

VOYAGE

FUSION THERMAL & DIGITAL
DAY/NIGHT VISION BINOCULAR
WITH BUILT-IN LASER RANGEFINDER

© 2023 AGM Global Vision, LLC. All rights reserved.

This documentation is subject to change without notice.

No parts of this manual, in whole or in part, may be copied, photocopied, translated, or transmitted by any electronic medium or in machine-readable form without the prior written permission of AGM Global Vision, LLC.

If you have questions that are not covered in this manual, or need service, contact AGM Global Vision customer support for additional information prior to returning a product.

AGM Global Vision, LLC

173 West Main Street

PO Box 962

Springerville, AZ 85938

Tel. 928.333.4300

support@agmglobalvision.com

www.agmglobalvision.com

EXPORT INFORMATION

Buyer acknowledges that all products supplied by AGM Global Vision, LLC are subject to U.S. export control laws, including, but not limited to, the Export Administration Regulations, the International Traffic in Arms Regulations, the International Economic Emergency Powers Act, and various U.S. embargoes and sanctions. AGM Global Vision products may not be exported, re-exported, or transferred contrary to U.S. export control laws. In particular, AGM Global Vision products may not be exported, re-exported, or transferred to prohibited countries, individuals, organizations, or entities, including but not limited to those individuals and entities listed on the List of Specially Designated Nationals and Blocked Persons administered or maintained by the U.S. Office of Foreign Assets Control ("OFAC"), the various lists maintained by the Bureau of Industry and Security of the Department of Commerce, and the U.S. State Department and Buyer represents and warrants that neither Buyer nor any of its officers, directors, or employees are on such lists. Distribution or resale by Buyer to such countries, individuals, organizations, or entities is expressly prohibited. Buyer has and will maintain a positive process to ensure compliance with this Section.

FCC INFORMATION

Please note that changes or modification not expressly approved by the party responsible for compliance could void the user's authority to operate the equipment.

This equipment complies with FCC/IC RSS-102 radiation exposure limits set forth for an uncontrolled environment.



FCC compliance: This product has been tested and found to comply with the limits for a Class B digital device, pursuant to Part 15 of the FCC Rules. These limits are designed to provide reasonable protection against harmful interference in a residential installation.

This product generates, uses, and can radiate radio frequency energy and, if not installed and used in accordance with the instructions, may cause harmful interference to radio communications. However, there is no guarantee that interference will not occur in a particular installation. If this product does cause harmful interference to radio or television reception, which can be determined by turning the equipment off and on, the user is encouraged to try to correct the interference by one or more of the following measures:

- Reorient or relocate the receiving antenna.
- Increase the separation between the equipment and receiver.
- Connect the equipment into an outlet on a circuit different from that to which the receiver is connected.
- Consult the dealer or an experienced radio/TV technician for help.

FCC Conditions

This device complies with part 15 of the FCC Rules. Operation is subject to the following two conditions:

1. This device may not cause harmful interference.
2. This device must accept any interference received, including interference that may cause undesired operation.

EU CONFORMITY STATEMENT



This product and - if applicable - the supplied accessories too are marked with "CE" and comply therefore with the applicable harmonized European standards listed under the EMC Directive 2014/30/EU, the RoHS Directive 2011/65/EU



2012/19/EU (WEEE directive): Products marked with this symbol cannot be disposed of as unsorted municipal waste in the European Union. For proper recycling, return this product to your local supplier upon the purchase of equivalent new equipment, or dispose of it at designated collection points. For more information see: www.recyclethis.info



2006/66/EC (battery directive): This product contains a battery that cannot be disposed of as unsorted municipal waste in the European Union. See the product documentation for specific battery information. The battery is marked with this symbol, which may include lettering to indicate cadmium (Cd), lead (Pb), or mercury (Hg). For proper recycling, return the battery to your supplier or to a designated collection point. For more information see: www.recyclethis.info

INDUSTRY CANADA ICES-003 COMPLIANCE

This device meets the CAN ICES-3 (B)/NMB-3(B) standards requirements.

LIST OF CONTENTS

TITLE	PAGE
Safety Summary	5
1. GENERAL INFORMATION	7
1.1 System Description	7
1.2 Standard Components	8
1.4 Key Features	9
2. OPERATING INSTRUCTIONS	10
2.1. Basic Operations	10
2.2 Main Function	15
2.3 Client Software Introduction	24
3. MAINTENANCE	25
3.1 Maintenance	25
3.2 Troubleshooting	26
4. WARRANTY INFORMATION	27
4.1 Warranty Information and Registration	27
5. SPECIFICATIONS	29
5.1 Specifications	29

SAFETY SUMMARY

- Read and follow all instructions
- Read all warnings
- Only use the attachments/accessories specified by the manufacturer
- All service must be provided by the manufacturer

WARNING:

This product contains natural rubber latex, which may cause potentially fatal allergic reactions! If you are allergic to latex, it is important that you strictly avoid exposure to products that contain it.

WARNING AND CAUTIONS:

Transportation

- Keep the device in original or similar packaging while transporting it.
- Keep all wrappers after unpacking them for future use. In case of any failure occurred, you need to return the device to the factory with the original wrapper. Transportation without the original wrapper may result in damage on the device and the company shall not take any responsibilities.
- DO NOT drop the product or subject it to physical shock. Keep the device away from magnetic interference.

Power Supply

- The battery charger is included in the package. The input voltage for the supplied battery charger should meet the Limited Power Source (5 VDC, 2 A).
- The power source should meet limited power source or PS2 requirements according to IEC 60950-1 OR ICE 62368-1 standard.
- Make sure the plug is properly connected to the power socket.
- DO NOT connect multiple devices to one power adapter, to avoid overheating or fire hazards caused by overload.

Battery

- Improper use or replacement of the battery may result in explosion hazard. Replace with the same or equivalent type only.
- The battery type is 18650 with the protection board, and the battery size should be 19 mm × 70 mm. The rated voltage is 3.6 VDC, and the battery capacity is 3200 mA. Dispose of used batteries in conformance with the instructions provided by the battery manufacturer.
- Make sure the battery temperature is between 0 °C to 45 °C (32 °F to 113 °F) when charging.
- For long-term storage of the battery, make sure it is fully charged every half year to ensure the battery quality. Otherwise, damage may occur.
- Do not charge other battery types with the supplied charger. Confirm there is no flammable material within 2 m of the charger during charging.
- DO NOT place the battery near heating or fire source. Avoid direct sunlight.
- DO NOT swallow the battery to avoid chemical burns.

- DO NOT leave the battery in places accessible for children.
- The battery cannot be charged with external power source directly.
- The device cannot be charged, please use the supplied charger to charge the replaceable battery.

Maintenance

- If the product does not work properly, please contact your dealer or the nearest service center. We shall not assume any responsibility for problems caused by unauthorized repair or maintenance.
- Wipe the device gently with a clean cloth and a small quantity of ethanol, if necessary.
- If the equipment is used in a manner not specified by the manufacturer, the protection provided by the device may be impaired.
- Clean the lens with soft and dry cloth or wiping paper to avoid scratching it.

Using Environment

- Make sure the running environment meets the requirement of the device. The operating temperature shall be -30°C to 55°C (-22°F to 131°F), and the operating humidity shall be 95% or less.
- DO NOT expose the device to extremely hot, cold, dusty, corrosive, saline-alkali, or damp environments.
- Avoid equipment installation on vibratory surface or places subject to shock (neglect may cause equipment damage).
- DO NOT aim the lens at the sun or any other bright light.

EMERGENCY:

- If smoke, odor, or noise arises from the device, immediately turn off the power, unplug the cable, and contact the service center.

1 GENERAL INFORMATION

1.1 SYSTEM DESCRIPTION

The Voyage series of Fusion Thermal & Digital Day/Night Vision binoculars are equipped with a 12 μ m high-sensitivity infrared thermal sensor (NETD < 20 mK) and 2560 \times 1440 ultra-low light optical detector. The device can quickly discover and locate hiding objects even under extreme environments, such as smoke, fog, rain and snow. Digital night vision channel is great for aiding in recognition of targets after the thermal channel has detected a potential target. The binocular offers a variety of image modes including thermal, visible, fusion, and is easily adaptable to different environmental conditions. Voyage can be widely applied to law enforcement scenarios, as well search-and-rescue, drug enforcement, anti-smuggling, hiking, and hunting.

The waterproof housing ensures performance in severe weather conditions and challenging environments. The Voyage's user-friendly interface and ergonomic buttons makes adoption and application intuitive and simple.

The Voyage is equipped with all key features for target detection and positioning, including the built-in 1000m laser rangefinder, GPS module, electronic compass, inclinometer, and 850nm IR illuminator.

The binocular also has 64GB built-in memory for video recording and image capture. WiFi hotspot function allows to use the device in conjunction with mobile phones and tablets via the AGM Connect app. This high-tech binocular can take three 18650 rechargeable Lithium batteries for 8 hours of operation using an integrated proximity sensor for energy saving.

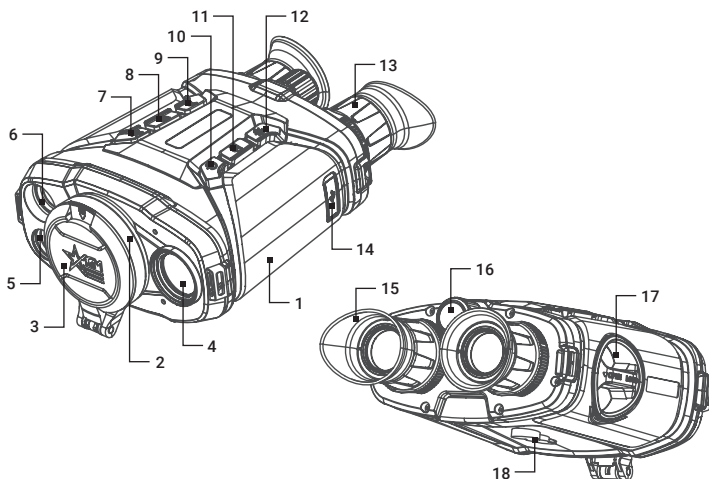

FIGURE 1-1. MAIN PARTS

TABLE 1-1. MAIN PARTS

ITEM	DESCRIPTION	ITEM	DESCRIPTION
1	Body	10	Power Button
2	Thermal Lens	11	Capture Button
3	Lens Cap	12	Laser Button
4	Optical Lens	13	Diopter Adjustment Ring
5	Infrared Light	14	USB Type-C Interface
6	Laser Ranger Finder	15	Eyecup
7	Mode Button	16	Focus Knob
8	Menu Button	17	Battery Compartment
9	Zoom Button	18	Tripod Mount

1.2 STANDARD COMPONENTS

The standard components are shown in Figure 1-2 and listed in Table 1-2. The ITEM column indicates the number used to identify items in Figure 1-2.

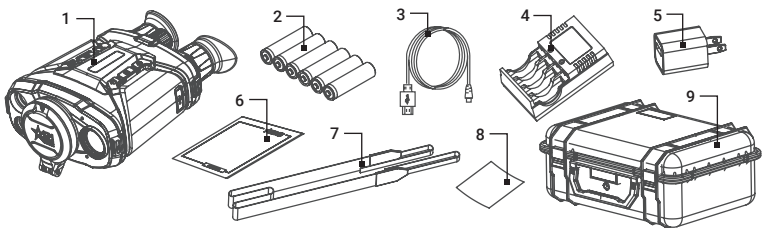

FIGURE 1-2. STANDARD COMPONENTS

TABLE 1-2. STANDARD COMPONENTS

ITEM	DESCRIPTION	QUANTITY
1	Binocular	1
2	18650 Rechargeable Battery	6
3	USB Cable	1
4	Battery Charger	1
5	Power Adapter	1
6	User Manual	1
7	Neck Strap	1
8	Lens Cloth	1
9	Hard Case	1

1.3 KEY FEATURES

- Dual-spectrum image fusion and object highlight (detail enhancement and target recognition)
- Selection of thermal view channel, visible light channel, or both them combined
- Thermal resolution: 384x288 or 640x512
- Optical resolution: 2560x1440
- NETD less than 20 mK (25°C, F#=1.0)
- Digital Detail Enhancement (DDE)
- Dynamic Noise Reduction (3D DNR)
- Adaptive Automatic Gain Control (AGC)
- Ultra-low illumination (optical channel), B/W: 0.001 lux
- Video recording, replay, image capture and search (capable to review the event on device)
- Wi-Fi hotspot
- Eye-safe laser rangefinder (up to 1,000 m distance detection with measuring accuracy 1 m)
- GPS module
- Digital magnetic compass
- Inclination sensor
- Proximity sensor to save power
- Up to 8 hours continuous operation
- Waterproof, IP67
- 5-year warranty (depending on the region of sale)

2 OPERATING INSTRUCTIONS

2.1. BASIC OPERATIONS

2.1.1 UNPACKING

The following steps must be completed prior to each mission.

1. Open the carrying case, remove the device, and verify that all components are included.
2. Inspect the device for any obvious evidence of damage to the optical surfaces, body, eyecup, operation buttons, etc. Ensure that all optical surfaces are clean and ready for use. Clean all optical surfaces with a lens tissue.

2.1.2 BATTERY INSTALLATION

Insert the batteries into the battery compartment.

1. Rotate the battery compartment cover counterclockwise to loosen it.
2. Take out the detachable battery compartment, and install three 18650 batteries as the positive and negative marks indicate.
3. Install the battery compartment back, and rotate the battery compartment cover clockwise to lock it.

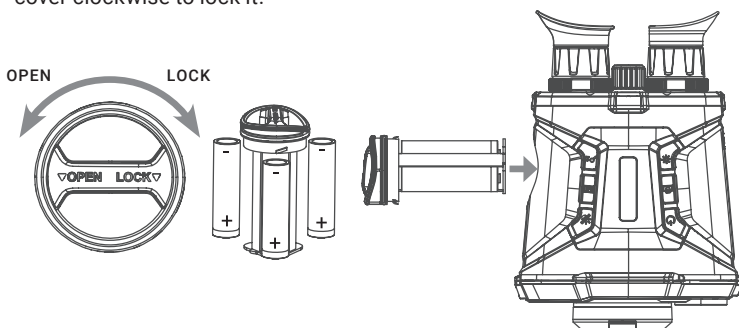

FIGURE 2-1. BATTERY INSTALLATION

NOTE:

Take the battery away if you do not use the device for a long time.

Charge the batteries with the supplied battery charger for more than 4 hours before first use.

The battery type is 18650 with the protection board, and the battery size should be within 19 mm × 70 mm. The rated voltage and capacity are 3.6 VDC/3.2 Ah.

2.1.3 CONTROL BUTTONS

The Voyage controls are shown in Figure 2-2 and are defined in Table 2-1.

Each button is responsible for some functions selected by short press or long press (hold) the button. Pushing a button for 2+ second is considered “long press” (hold).

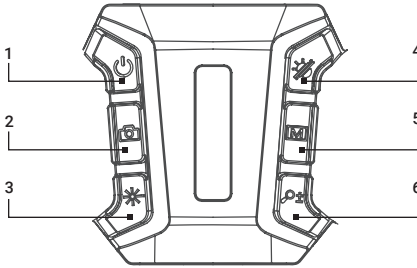







FIGURE 2-2. CONTROLS

TABLE 2-1. VOYAGE CONTROL FUNCTIONS



ITEM	CONTROLS	FUNCTIONS
1	 POWER BUTTON	Press: Standby Mode / Wake Up Device Hold: Power ON/OFF
2	 CAPTURE BUTTON	Press: Image Capture Hold: Start/Stop Video Recording
3	 LASER BUTTON	Press: Single Distance Measuring with Laser Rangefinder Hold: Continuously Distance Measuring with Laser Rangefinder
4	 MODE BUTTON	Press: Day/Night/Defog/Auto Mode Switching Hold: Display Non-uniformity Correction
5	 MENU BUTTON	Press: Palette Switching Hold: Enter/Exit menu
6	 ZOOM BUTTON	Press: Switching Digital Zoom Hold: Enable/Disable PIP

2.1.4 POWER ON AND OFF

Power On

When the battery is enough, hold the POWER button  for about 2 seconds to power on the device.

NOTE

See the battery icon on the device display for the electricity quantity. Icon  means the battery is fully charged, and icon  means that the battery is low. When the low power note shows, charge the battery.

Power Off

When the device is turned on, hold the POWER button (⏻) to power off the device.

Auto Power Off

In the “Auto Power Off” menu you can set the time for the automatic shutdown of the device as required (OFF / 30 min / 45 min).

The Auto Power Off function starts countdown when Standby mode enable. The auto power off countdown is disabled when the device wakes up from standby. The countdown will be restarted when the device is put into standby mode again.

2.1.5 ON-SCREEN DISPLAY (OSD)

On-screen interface displays the main setup menu items and device status indicators. Refer to the Figure 2-3 for the main view of the display.

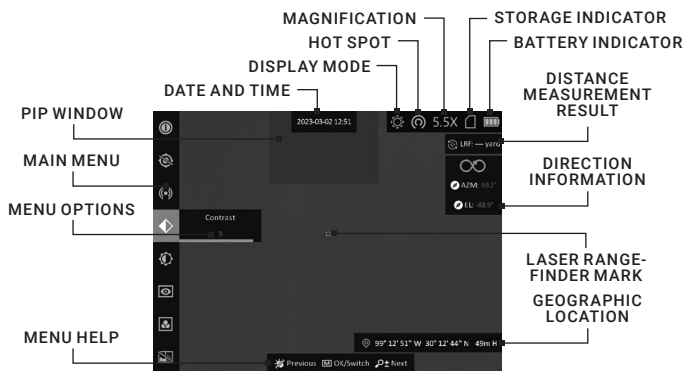

FIGURE 2-3. ON-SCREEN DISPLAY

2.1.6 STANDBY MODE

Standby mode is used to save battery power. In the view mode, press the POWER button (⏻). After a few seconds, the display will turn off. Press the POWER button (⏻) again to exit the Standby mode.

2.1.7 THERMAL VIEW OBSERVATION

1. Power on the device.
2. Hold the device and make sure the eyepiece covers your eye.
3. Adjust the diopter adjustment rings until the OSD text or image is clear.
4. Point the device towards the target of the view. Bring the object into focus by rotate the objective focus knob.

NOTE:

You must perform the focus adjustment before any further use of the Binocular.

5. Set palette, brightness, contrast, scene mode and FFC (Flat Field Correction), to display the best image effect.

2.1.8 PALETTE SETTINGS

You can select different palettes to display the same scene in different effects. Press the MENU button  in live view interface to switch palettes.

TABLE 2-2. PALETTE SETTINGS

PALETTE	DESCRIPTION
WHITE HOT	The hot part is white-colored in view. The higher the temperature is, the lighter the color is.
BLACK HOT	The hot part is black-colored in view. The higher the temperature is, the more black the color is.
FUSION	From high temperature to low temperature, the image is colored in from white, yellow, red, pink to purple.
RED HOT	The hot part is red-colored in view. The higher the temperature is, the redder the color is.
OPTICAL	The image of optical channel is displayed in this mode.
IMAGE FUSION	Fuse the optical image with the thermal image. The fused image with clear edge is displayed in this mode.

2.1.9 SET DISPLAY MODE

You can select different display modes in different scenes.







Press the MODE button  in live view interface to switch display modes. Day, Night, Defog, and Auto are selectable. The current mode is displayed on the right top of the display interface.

TABLE 2-3. DISPLAY MODE

SYMBOL	MODE	DESCRIPTION
	Day	Full-color image for daytime.
	Night	Black & white viewing at night.
	Auto	Allows to optimize the image in various lighting conditions.
	Defog	Increases ability to detect IR information in fog.

2.1.10 DIGITAL ZOOM

You can zoom the image by using this function.

Press the ZOOM button  in the view mode, and the digital zoom switches from 1x to 2x, 4x, 8x, and 16x. The image magnification value is displayed on the screen:

- AGM Voyage TB50-384: 5.5x, 11x, 22x, 44x, 88x
- AGM Voyage TB50-640: 3.5x, 7x, 14x, 28x, 56x
- AGM Voyage TB75-640: 5x, 10x, 20x, 40x, 80x

2.1.11 PICTURE IN PICTURE MODE

Hold the ZOOM button (⊕) in live view mode to enable PIP, and hold the ZOOM button (⊕) again to exit PIP. The image center is displayed in upper middle of the interface.

2.1.12 SHUTTER RELEASE

Hold the MODE button (⊗) in the view mode to release the shutter once for correction of the non-uniformity of display (see 2.2.8 for more information).

2.1.13 VIDEO RECORDING AND IMAGE CAPTURE

Video Recording

In the live view interface, hold the CAPTURE button (Ⓢ) to start recording, and hold the CAPTURE button (Ⓢ) again to stop recording.

Image Capture

In the live view interface press the CAPTURE button (Ⓢ) at the same time to capture the image.

NOTE:

When capturing, the image freezes for 1 second and a prompt shows on the display.

2.1.14 CONNECTING THE DEVICE

1. Open the USB interface cover.
2. Connect the device and power supply with a USB cable to external power the device. Alternatively, connect the device and PC with a USB cable to copy/delete files.

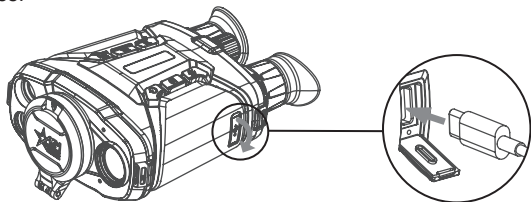

FIGURE 2-4. TYPE-C USB INTERFACE

2.1.15 FILE EXPORT

1. Connect the binocular to your PC with USB cable and open the detected disk.
2. Open file manager and select the disk of device. Go to the DCIM folder and find the folder named after the capture year and month. For example, if you capture a picture or record a video on January 2023, go to DCIM -> 202301 to find the picture or video.
3. Select and copy the video and image files to PC for viewing.
4. Disconnect the device from your PC.

NOTE:

The device displays images when you connect it to PC. But functions such as recording, capturing and WiFi hotspot are disabled.

2.2 MAIN FUNCTIONS

2.2.1 MENU OPERATION

When the device is turned on, hold the MENU button (M) to display the menu. Press the ZOOM button (Z) or the MODE button (M) to select options, and press the MENU button (M) to confirm. Hold the MENU button (M) to exit the menu.

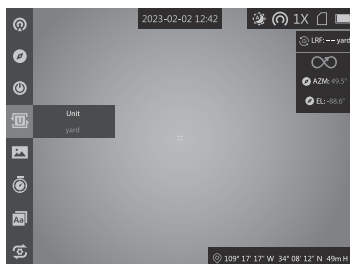





























FIGURE 2-5. THE MAIN MENU

TABLE 2-4. MENU FUNCTION

MENU ITEM	SYMBOL	OPTION	FUNCTION
CONTRAST		10 Levels of Contrast	Adjusts the image contrast.
BRIGHTNESS		10 Levels of Brightness	Adjusts the image brightness.
SCENE MODE		Recognition	Switch between the Recognition mode and Jungle mode.
		Jungle	
CUSTOM PALETTES		6 Palettes	Palette selection: White Hot, Black Hot, Fusion, Red Hot, Optical, Image Optical.
IMAGE BOOST		ON	Enables or disables the Image Boost function.
		OFF	
FUSION LEVEL		56~90 m (yd), 90~228 m (yd), >228 m (yd)	Select the level of image fusion.
IMAGE CALIB.		Auto FFC/ Manual FFC/ External	Selecting the Flat Field Correction (FFC) mode.
DPC		Axis: N/X/Y	Manual correction of dead pixels.
LASER RANGING		ON (15s/30s/ 1m/2m/5m)	Enables or disables the Laser Ranging. Switching the time of continuous distance measurement.
		OFF	

MENU ITEM	SYMBOL	OPTION	FUNCTION
BURN- PREVENTION		ON	Enables or disables the Burn Prevention function.
		OFF	
SMART IR		ON	Helps to adjust the overexposed images, and it can improve the image in night mode.
		OFF	
INFRARED LIGHT		ON	Enables or disables Infrared Light.
		OFF	
AUDIO		ON	Enables or disables audio recording.
		OFF	
OSD		ON	Enables or disables OSD, Time and Date.
		OFF	
CVBS		ON	Enables or disables the CVBS Output function to view the video on CVBS monitor.
		OFF	
GPS		ON	Enables or disables GPS.
		OFF	
COMPASS		ON	Enables or disables Compass. Magnetic declination correction.
		OFF	
AUTO POWER OFF		OFF / 30 min / 45 min	Setting the automatic shutdown time.
UNIT		yard / m	Sets the distance unit.
ALBUMS		Albums	Selection an album and file to view on the display.
TIME SYNC.		Time Format / Time / Date	Setting the time and date.
LANGUAGE		20 Languages	Choice of interface language.
RESTORE		---	Restoring the default device settings.
VERSION		---	View the firmware version number and serial number.
HOT TRACKING		ON	Enables or disables hot spot mark (marking the spot of highest temperature).
		OFF	
NETWORK		OFF	Enables or disables the Wi-Fi hotspot.
		Hotspot	

2.2.2 CONTRAST ADJUSTMENT

1. Hold the MENU button (M) to go to the menu.
2. Select  Contrast menu item and press the MENU button (M) to adjust the image contrast.

You can select one of ten levels of the contrast.



2.2.3 BRIGHTNESS ADJUSTMENT

1. Hold the MENU button (M) to go to the menu.
2. Select  Brightness menu item and press the MENU button (M) to adjust the brightness.

You can select one of ten levels of the brightness to adjust the image lighter or darker.

2.2.4 SCENE MODE

You can select proper Scene Mode according to environment temperature to improve the display effect.

1. Hold the MENU button (M) to go to the menu.
2. Select  /  Scene Mode menu item ( is default option) and press the MENU button (M) to switch scene.

Recognition mode () improves an image so that the object edge is more distinct.

Jungle mode () is more suitable for hunting environment because of the highlight function of small objects.

2.2.5 CUSTOM PALETTES

You can select different palettes to display the same scene in different effects.

1. Hold the MENU button (M) to go to the menu.
2. Select  Custom Palettes menu item .
3. Press the MENU button (M) to go to the palettes interface.
4. Press the ZOOM button (Z) or the MODE button (M) to select the palettes required, and press the MENU button (M) to enable it/them.

NOTE:

At least one palette should be enabled. The default palettes are White Hot, Optical, and Fusion.

5. Hold the MENU button (M) to exit.
6. Press the MENU button (M) in live view interface to switch the selected palettes.

2.2.6 IMAGE BOOST

The Image Boost function enhances image detail.

1. Hold the MENU button (M) to go to the menu.
2. Select  Image Boost menu item .
3. Press the MENU button (M) to enable this function.

4. Hold the MENU button (M) to return to the live view interface, and view the target.

The details of the whole live view image will be enhanced.

2.2.7 FUSION LEVEL

When the palette is set as image fusion, you can adjust the fusion level according to the actual observation distance to obtain better image fusion effect.

1. Hold the MENU button (M) to go to the menu.
2. Select (F) Fusion Level menu item.
3. Press the MENU button (M) to switch fusion level.

2.2.8 IMAGE CALIBRATION (FLAT FIELD CORRECTION)

The Image calibration function in the Rattler performs the so-called Flat Field Correction (FFC) can correct non-uniformity of display. During correction, a shutter will be lowered in front of the detector. A click is heard and the image is momentarily interrupted. In this case, the detector is calibrated and the image becomes more accurate.

1. Hold the MENU button (M) to go to the menu.
2. Select (C) Image Calib. menu item and press the MENU button (M) to switch the FFC mode between **Manual FFC**, **Auto FFC** and **External**.

Manual FFC: Enter Trigger Calibration in the menu and press the MENU button (M) to correct the non-uniformity of display.

Auto FFC: The Binocular performs FFC automatically when switching on or rebooting the camera.

External: Cover the lens cap, then enter Trigger Calibration in the menu and press the MENU button (M) to correct the non-uniformity of display.

2.2.9 DEFECTIVE PIXELS CORRECTION

Defective Pixels Correction (DPC) function can correct the defective pixels on the screen which are not performed as expected.

Before you start switch the palettes mode to White Hot mode.

1. Hold the MENU button (M) to go to the menu.
2. Select (D) DPC menu item, and press the MENU button (M) to enter the DPC setting interface.
3. In the DPC Interface, press the ZOOM button (Z) or the MODE button (M) to select **Axis**, and press the MENU button (M) to switch the moving direction of the cursor. If you select **X**, the cursor moves left and right; if you select **Y**, the cursor moves up and down.
4. Press the ZOOM button (Z) or the MODE button (M) to move the cursor until it reaches the defective pixel.
5. Press the MENU button (M) to set the axis as **N**, and press the ZOOM button (Z) or the MODE button (M) to select **DPC**.
6. Press the MENU button (M) to correct the defective pixel.

NOTE:

The selected defective pixel can be magnified and displayed at the bottom right of the interface.

When the menu or OSD blocks the defective pixel, the menu at the bottom can be hidden, and the menu at the upper left can be mirrored to the upper left of the interface.



2.2.10 DISTANCE MEASUREMENT

The device can detect the distance between the target and the observation position with laser.

When measuring the distance, keep the hand and the position steady. Otherwise, the accuracy may be affected.

1. Hold the MENU button (M) to go to the menu.
2. Select  Laser Ranging menu item, and press (M) to enter the laser ranging setting interface.
3. Press the MENU button (M) to enable Laser Ranging.
4. Press the ZOOM button (P±) or the MODE button (M) to select Continuous, and press the MENU button (M) to start setting continuous distance measurement time.
5. Press the ZOOM button (P±) or the MODE button (M) to switch the continuous distance measurement time, and press the MENU button (M) to confirm.
6. Hold the MENU button (M) to return to the live view interface, and aim the cursor at the target.
7. Press the LASER button (L*) to measure target distance once, and hold the LASER button (L*) to measure target distance continuously.

The distance measurement result is displayed at the upper right of the image.

OSD symbol  means measuring the distance continuously. The measurement result will be refreshed every 1s. Symbol  means measuring the distance once.

2.2.11 BURNING PREVENTION

This function can prevent the detector of the thermal channel from being burned. When you enable this function, the shield will close if the grey scale of the detector reaches a certain value.



1. Hold the MENU button (M) to go to the menu.
2. Select  Burn-prevention menu item and press the MENU button (M) to enable or disable the Burning prevention function.

NOTE:



When the burn-prevention function is disabled, the shield should be opened if it closes.

2.2.12 SMART IR

Image overexposure may occur in too bright environment. The smart IR function helps to adjust the overexposed images by controlling infrared light intensity, so as to improve the image effect in night mode and dark environment.

In menu mode, select  Smart IR menu item and press the MENU button  to enable this function.

2.2.13 INFRARED LIGHT



The infrared light helps to view targets clearly in dark environment. Select  Infrared Light menu item in menu mode, and press the MENU button  to turn on infrared light. After you enable this function, the infrared light only works in night mode, or in auto mode and the dark environment. In other modes, the infrared light does not take effect.

NOTE:

Infrared light cannot be turned on if the battery is low.







2.2.14 AUDIO RECORDING

If you enable the audio function, the sound will be recorded with the video. When there is too loud noise in the video, you can disable this function.

1. Hold the MENU button  to go to the menu.
2. Select  Audio menu item.
3. Press the MENU button  to enable or disable this function.

2.2.15 OSD

You can choose whether to display the OSD information on the live view interface in this function.

1. Hold the MENU button  to go to the menu.
2. Select  OSD menu item and press the MENU button  to enter.
3. Press the MENU button  to select the , time or date. Press the MENU button  to switch on/off mode and confirm.



2.2.16 CVBS OUTPUT

You can view the video on CVBS monitor, to get a better and clear image, more convenient to check the detail.

1. Connect the USB-CVBS cable to USB port of thermal binocular and to monitor's CVBS port.



NOTE:

- USB-CVBS cable need to be purchase separately.
- CVBS Output function doesn't support hot plug, so please connect the cable before power on.

2. Hold the MENU button  to go to the menu.
3. Select  CVBS menu item and press the MENU button  to turn on or turn off the CVBS video output.

2.2.17 GPS

Equipped with satellite positioning modules, the device is able to display the longitude and latitude, as well as the sea level altitude of the device on the live image, captured images, and recorded videos.



In menu mode, select  GPS menu item and press the MENU button  to enable the satellite positioning modules. You can see the location displayed at lower right corner of the screen.

NOTE:

- The satellite module is not able to receive signals when the device is indoor. Place the device in an empty outdoor space to receive signals.
- In an outdoor space, wait for a moment for the device to display its location.
- Location display is only supported by models with satellite positioning modules.

2.2.18 COMPASS

Equipped with a compass, the device is able to display its direction on the live image, captured images, and recorded videos.

In menu mode, select  **Compass** menu item and press the MENU button  to enable the compass modules, then follow the pop-up instructions to calibrate the compass. See Calibrate Compass for more information.

After successful calibration, you can see the direction displayed at up right corner of the screen. It is recommended to read the direction when you lay the device horizontally.

To increase the direction accuracy, you can set the magnetic declination correction. See Magnetic Declination Correction for instructions.

2.2.19 CALIBRATE COMPASS

Compass calibration is a must for correction direction display.

You need to calibrate the compass when you enable the function for the first time, or when the compass is magnetically interfered, and the direction information displays red.

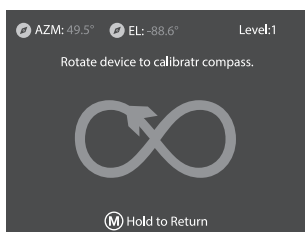



FIGURE 2-6. CALIBRATE COMPASS

1. Call the calibration guide by the following ways.
 - When you enable compass for the first time, the compass calibration guide pops up.
 - When the compass information displays red, select  Compass in menu mode and press the MENU button  to re-enable compass.
2. Follow the screen instructions to move and rotate the device.

NOTE:

During calibration, keep moving and rotating the device to make sure that the device faces every possible directions.



Calibration Level indicates the validity of calibration. Higher level means more accurate compass reading. Calibration succeeds when the Calibration Level turns to 3.

3. Stop moving the device when calibration success message pops up.





The direction information is displayed on the up right of the live view image.

2.2.20 MAGNETIC DECLINATION CORRECTION

Magnetic declination is the angle variation between magnetic north and true north. Adding the magnetic declination to the compass increase the accuracy of direction reading.

1. After the compass is calibrated, go to the compass setting interface, and press the ZOOM button  or the MODE button  to select Magnetic Declination Correction.



2. Press the ZOOM button  or the MODE button  to select Quick Correction or Manual Correction.

- In quick correction, the device display the current declination to magnetic north. Point screen center to true north and press the MENU button .
- In manual correction, press the MENU button  to select the operational symbol or number, and then press the ZOOM button  or the MODE button  to add or subtract the declination of device location.

2.2.21 AUTO POWER OFF



You can set the time for the automatic shutdown of the device as required.

1. Hold the MENU button  to go to the menu.

2. Select  Auto Power Off menu item and press the MENU button  to select OFF, 30 min or 45 min.



2.2.22 UNIT



1. Hold  to show the menu.



2. Select  Unit and press the MENU button  to switch the unit of measurement for distance. Hold the MENU button  to exit.

2.2.23 TIME SYNCHRONIZATION

1. Hold the MENU button  to go to the menu.

2. Select  Time Sync. menu and press the MENU button  to enter the Time Sync.

3. Press the MENU button  to switch the time system, and press the ZOOM button  or the MODE button  to select the time and date to be synchronized.

4. Press the MENU button  to select the hour, minute, second, year, month, or day to be synchronized, and then press the ZOOM button  or the MODE button  again to change the number.

2.2.24 LANGUAGE SETTING

You can select different languages of user interface.

1. Hold the MENU button (M) to go to the menu.
2. Select **Language** menu item, and press the MENU button (M) to enter the language configuration interface.
3. Press the ZOOM button (Z) or the MODE button (M) to select the language as required, and press the MENU button (M) to confirm.

2.2.25 RESTORE DEVICE

You can reset the settings of device.

1. Hold the MENU button (M) to go to the menu.
2. Select **Restore** menu item and press the MENU button (M) to restore the device to defaults according to the prompt.

2.2.26 VIEW DEVICE INFORMATION

You can view the device information such as firmware version, and serial number.

1. Hold the MENU button (M) to go to the menu.
2. Select **Version** menu item and press the MENU button (M). The firmware version, and serial number will be displayed on the screen.

2.2.27 HOT TRACKING

The device can detect the highest temperature spot in the scene and mark it on display.

1. Hold the MENU button (M) to go to the menu.
2. Select **Hot Tracking** menu item and press the MENU button (M) to mark the spot of highest temperature.

When the hot spot mark is enabled, the **-|-** mark displays in the spot of the highest temperature. When the scene changes, the **-|-** mark moves.

2.2.28 NETWORK CONFIGURATION

Connect your phone to the Wi-Fi hotspot of the binocular, you can configure the parameters and realize functions of the device.

1. Hold the MENU button (M) to go to the menu.
2. Select **Hotspot** menu item and press the MENU button (M) to enable or disable Wi-Fi hotspot
3. Hold the MENU button (M) to exit.

Open the AGM Connect APP and connect your phone with the device (refer to Section 2.3). You can view the interface of rifle scope on your phone.

NOTE:

When the power is less than 15%, the Wi-Fi hotspot function will be turned off automatically.

2.3 CLIENT SOFTWARE INTRODUCTION

Search the AGM Connect software in App Store (iOS System) or Google Play™ (Android System) and install the application on your mobile phone. Turn on the Wi-Fi hotspot on the thermal device and then connect your phone to the hotspot.

- Hotspot Name: Wlan-<Serial No.>

- Hotspot Password: Last 9 digits of Serial Number of your thermal device.

NOTE:

The device password is set by user at first activation. If the password was lost or forgotten, it can be reset. To reset a password perform the following steps:

1. When the binocular is turned on, hold the MENU button (M) to activate the OSD menu.
2. Select  menu item and press the MENU button (M) to restore all parameters to default settings.

1. Run the app and connect the phone or tablet with the device.
2. If the device is inactivated, set the password and activate it. If the device is activated, enter the password to add it to the app.
3. When the device is added, the live view can be seen. You can view the interface of the device on the software. User can change such image parameters as brightness, contrast, zoom, palettes directly via phone or tablet as well as record video on phone/tablet memory.

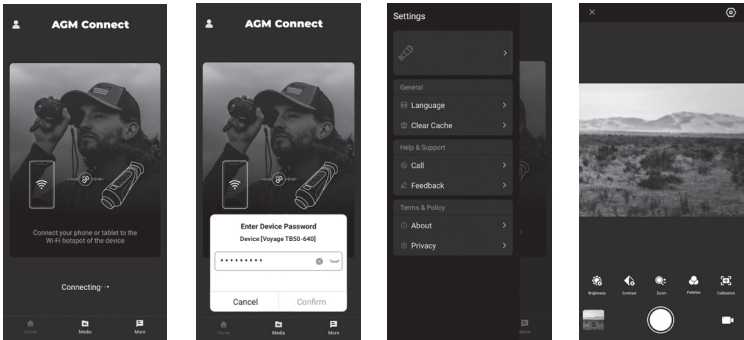

FIGURE 2-11. AGM CONNECT APP

3 MAINTENANCE

3.1 MAINTENANCE

3.1.1 CLEANING PROCEDURES

1. Gently brush off any dirt from the body of the device using a clean, soft cloth.
2. Moisten the cloth with fresh water and gently wipe down the external surfaces (except lenses).
3. Dry any wet surfaces (except lenses) using another dry, clean, soft cloth.
4. Using a lens brush, carefully remove all loose dirt from the lenses.
5. Dampen a cotton swab with ethanol and slowly, gently wipe down the lenses. Clean the glass surfaces using circular movements, starting from the center of the lens and moving out towards the edge, without touching the lens holder. Change the cotton swab after each circular stroke. Repeat this step until the glass surfaces are clean.
6. Clean the accessories with a soft brush (or cloth) dampened with soap and water.

3.1.2 PREPARING FOR EXTENDED STORAGE

CAUTION:

Thoroughly dry each item before placing them into the storage case.

To prepare the device for extended storage:

1. Clean the device and accessories.
2. Place all items into the storage case.
3. Make sure to remove the battery from the unit.

3.1.3 UPDATING THE DEVICE FIRMWARE

1. Visit www.agmglobalvision.com/firmware website. Select your product, download the firmware update package to your PC and unzip it. Follow the detailed instructions on the website.
2. Connect the device to your PC with USB cable.
3. Turn on the device. Make sure the Wi-Fi hotspot function is disabled.
4. Open the detected disk (USB drive) in file manager program. Copy the unzipped digicap.dav file and paste it to the root directory of the device.
5. Turn off the device completely, then power it back on. After awhile, the firmware update process will start automatically. During the update, the screen will display the inscription "Upgrading...". The update process will be completed when the inscription "Upgrading..." goes out.

6. Turn off the device and disconnect it from your PC.

You can also enjoy automatic update function in AGM Connect App (see section 2.3 for details).

1. Start the AGM Connect App and tap the Settings icon in the left top corner.
2. Tap your device in the device list. The information about your device will shown.
3. Tap **Checking for Upgrade** to detect and download the latest FW version.

3.2 TROUBLESHOOTING

Table 3-1 lists the most common malfunctions that may occur with your equipment. Perform the tests, inspections, and corrective actions in the order they appear in the table.

This table does not list all the malfunctions that may occur with your device, or all of the tests, inspections, and corrective actions that may be necessary to fix them. If the equipment malfunction is not corrected by the suggested actions, or a problem occurs that is not listed in this table, please contact AGM Global Vision's Customer Support center or your retailer.

TABLE 3-1. TROUBLESHOOTING

MALFUNCTION	CORRECTIVE ACTION
The binocular fails to activate.	<ol style="list-style-type: none">1. Batteries are missing or improperly installed. Insert batteries or install correctly.2. Batteries are dead. Replace the batteries.3. Batteries, surfaces or contacts are dirty or corroded. Clean the contacts.
Device power indicator is off.	Examine whether the device is off-battery.
The image of the binocular is not clear.	Perform the binocular adjustment referring to section 2.1.
Wi-Fi is not found.	Examine whether the Wi-Fi function is turned on. If not, go to OSD menu and turn on Wi-Fi.
Image capture or video recording fails.	Examine the items below: <ol style="list-style-type: none">1. Whether the device is connected to your PC and disabled the capture and recording.2. Whether the storage space is full.3. Whether the device is low-battery.
The PC cannot identify the binocular.	Examine the items below: <ol style="list-style-type: none">1. Whether the device is connected to your PC with standard USB cable.2. If you use other USB cables, make sure the cable length is no longer than 1 m.

4 WARRANTY INFORMATION

4.1 WARRANTY INFORMATION AND REGISTRATION

The below description of AGM Global Vision warranty terms and conditions refer specifically to AGM branded products purchased within the United States. Customers purchasing AGM products outside the United States can obtain specific information about their product's warranty term on the www.agmglobalvision.eu website.

4.1.1 WARRANTY INFORMATION

This product is guaranteed to be free from manufacturing defects in material and workmanship under normal use for a period of five (5) years from the date of purchase. In the event that a defect covered by the warranty below occurs during the applicable period stated above, AGM Global Vision, at its discretion, will either repair or replace the product; such action on the part of AGM Global Vision shall be the full extent of AGM Global Vision's liability, and the Customer's sole and exclusive reparation. This warranty does not cover a product if it has been (a) used in ways other than its normal and customary manner; (b) subjected to misuse; (c) subjected to alterations, modifications or repairs by the Customer or by any party other than AGM Global Vision without prior written consent of AGM Global Vision; (d) is the result of a special order or categorized as "close-out" merchandise or merchandise sold "as-is" by either AGM Global Vision or the AGM Global Vision dealer; or (e) merchandise that has been discontinued by the manufacturer and either parts or replacement units are not available due to reasons beyond the control of AGM Global Vision. AGM Global Vision shall not be responsible for any defects or damage that in AGM Global Vision's view are a result from the mishandling, abuse, misuse, improper storage or improper operation of the device, including use in conjunction with equipment that is electrically or mechanically incompatible with, or of inferior quality to, the product, as well as failure to maintain the environmental conditions specified by the manufacturer. This warranty is extended only to the original purchaser. Any breach of this warranty shall be enforced unless the customer notifies AGM Global Vision at the address noted below within the applicable warranty period.

The customer understands and agrees that except for the foregoing warranty, no other warranties written or oral, statutory, expressed or implied, including any implied warranty of merchantability or fitness for a particular purpose, shall apply to the product. All such implied warranties are hereby and expressly disclaimed.

4.1.2 LIMITATION OF LIABILITY

AGM Global Vision will not be liable for any claims, actions, suits, proceedings, costs, expenses, damages, or liabilities arising out of the use of this product. Operation and use of the product are the sole responsibility of the Customer. AGM Global Vision's sole undertaking is limited to providing the products and services outlined herein in accordance with the terms and conditions of

this Agreement. The provision of products sold and services performed by AGM Global Vision to the Customer shall not be interpreted, construed, or regarded, either expressly or implied, as being for the benefit of or creating any obligation toward any third party of legal entity outside AGM Global Vision and the Customer; AGM Global Vision's obligations under this Agreement extend solely to the Customer. AGM Global Vision's liability hereunder for damages, regardless of the form or action, shall not exceed the fees or other charges paid to AGM Global Vision by the customer or customer's dealer. AGM Global Vision shall not, in any event, be liable for special, indirect, incidental, or consequential damages, including, but not limited to, lost income, lost revenue, or lost profit, whether such damages were foreseeable or not at the time of purchase, and whether or not such damages arise out of a breach of warranty, a breach of agreement, negligence, strict liability, or any other theory of liability.

4.1.3 PRODUCT REGISTRATION

In order to validate the warranty on your product, the customer must complete and submit AGM Global Vision PRODUCT REGISTRATION FORM on our website (www.agmglobalvision.com/customer-support).

4.1.4 OBTAINING WARRANTY SERVICE

To obtain warranty service on your unit, the End-user (Customer) must notify the AGM Global Vision service department via e-mail. Send any requests to support@agmglobalvision.com to receive a Return Merchandise Authorization number (RMA). When returning any device, please take the product to your retailer, or send the product, postage paid and with a copy of your sales receipt, to AGM Global Vision's service center at the address listed above. All merchandise must be fully insured with the correct postage; AGM Global Vision will not be responsible for improper postage or merchandise that becomes lost or damaged during shipment. When sending product back, please clearly write the RMA# on the outside of the shipping box. Please include a letter that indicates your RMA#, the Customer's Name, a Return Address, reason for the return, contact information (valid telephone numbers and/or an e-mail address), and proof of purchase that will help us to establish the valid start date of the warranty. Product merchandise returns that do not have an RMA# listed may be refused, or a significant delay in processing may occur. Estimated Warranty service time is 10-20 business days. The End-user/Customer is responsible for postage to AGM Global Vision for warranty service. AGM Global Vision will cover return postage/shipping after warranty repair to the End-user/Customer only if the product is covered by the aforementioned warranty. AGM Global Vision will return the product after warranty service by domestic UPS Ground service and/or domestic mail. Should any other requested, required, or international shipping methods be necessary, the postage/shipping fee will be the responsibility of the End-user/Customer.

For service, repair or replacement, please contact:

AGM Global Vision, LLC

173 West Main Street

PO Box 962

Springerville, AZ 85938

Tel. 928.333.4300

support@agmglobalvision.com

www.agmglobalvision.com

5 SPECIFICATIONS

5.1 SPECIFICATIONS

	VOYAGE TB35-384	VOYAGE TB35-640	VOYAGE TB50-640
THERMAL MODULE			
Image Sensor	12 μm VOx Uncooled Focal Plane Array	12 μm VOx Uncooled Focal Plane Array	12 μm VOx Uncooled Focal Plane Array
Resolution	384x288	640x512	640x512
Refresh Rate	25 Hz	25 Hz	25 Hz
Response Waveband	8 μm to 14 μm	8 μm to 14 μm	8 μm to 14 μm
NETD	Less than 20 mK (25°C, F#=1.0)	Less than 20 mK (25°C, F#=1.0)	Less than 20 mK (25°C, F#=1.0)
Lens System	50 mm, F0.9	50 mm, F0.9	75 mm, F1.2
Magnification	5.5x - 88x	3.5x - 56x	5x - 80x
Field of View	5.3° x 4.0°	8.7° x 7.0°	5.9° x 4.7°
Focusing	Manual focus	Manual focus	Manual focus
Digital Zoom	1x, 2x, 4x, 8x, 16x	1x, 2x, 4x, 8x, 16x	1x, 2x, 4x, 8x, 16x
Detection Range	2,600 m/yd (6' object)*	2,600 m/yd (6' object)*	3,600 m/yd (6' object)*
Focus Mode	Manual focus	Manual focus	Manual focus
Minimal Focus Distance	5 m	5 m	7.5 m
OPTICAL MODULE			
Max. Image Resolution	2560x1440	2560x1440	2560x1440
Image Sensor	1.88" Progressive Scan CMOS	1.88" Progressive Scan CMOS	1.88" Progressive Scan CMOS
Min. Illumination	B/W : 0.001 lux @ (F1.0, AGC On)	B/W : 0.001 lux @ (F1.0, AGC On)	B/W : 0.001 lux @ (F1.0, AGC On)
Lens System	31 mm, F1.2	31 mm, F1.2	31 mm, F1.2
IR Illuminator	Built-in 850 nm Smart IR	Built-in 850 nm Smart IR	Built-in 850 nm Smart IR
Night Viewing Range	400 m/yd *	400 m/yd *	400 m/yd *

IMAGE DISPLAY			
Monitor	0.39-inch, OLED, 1024x768	0.39-inch, OLED, 1024x768	0.39-inch, OLED, 1024x768
Diopter Adjustment	-5 to +3 dpt	-5 to +3 dpt	-5 to +3 dpt
Interpupillary Distance	60 mm to 70 mm	60 mm to 70 mm	60 mm to 70 mm
Eye Relief	15 mm	15 mm	15 mm
Image Mode	Optical, White Hot Thermal, Black Hot Thermal, Red Hot Thermal, Image Fusion	Optical, White Hot Thermal, Black Hot Thermal, Red Hot Thermal, Image Fusion	Optical, White Hot Thermal, Black Hot Thermal, Red Hot Thermal, Image Fusion
Optical Mode	Day, Night, Auto, Defog	Day, Night, Auto, Defog	Day, Night, Auto, Defog
Flat Field Correction	Auto, Manual, External Correction	Auto, Manual, External Correction	Auto, Manual, External Correction
PIP	Yes	Yes	Yes
LASER RANGEFINDER			
Measuring Distance	Max. 1,000 m	Max. 1,000 m	Max. 1,000 m
Accuracy	±1 m	±1 m	±1 m
Laser Wavelength	905 nm (Class 1)	905 nm (Class 1)	905 nm (Class 1)
SYSTEM			
Storage	Built-in memory module (64 GB)	Built-in memory module (64 GB)	Built-in memory module (64 GB)
Video Recording	MP4, 1600x1200	MP4, 1600x1200	MP4, 1600x1200
Snapshot Capture	JPEG, 1600x1200	JPEG, 1600x1200	JPEG, 1600x1200
Audio Recording	Yes	Yes	Yes
Local Album	Yes	Yes	Yes
Wi-Fi Hotspot	Yes	Yes	Yes
GPS	Yes	Yes	Yes
Digital Compass	Yes	Yes	Yes
Digital Inclinometer	Yes	Yes	Yes
Hot Track	Yes	Yes	Yes
Laser Rangefinder	Yes	Yes	Yes
Proximity Sensor	Yes	Yes	Yes
Standby Mode	Yes	Yes	Yes

POWER SUPPLY			
Battery Type	Three 18650 rechargeable batteries	Three 18650 rechargeable batteries	Three 18650 rechargeable batteries
Battery Operating Time	Up to 8 hours	Up to 8 hours	Up to 8 hours
Battery Capacity Display	Yes	Yes	Yes
External Power Supply	DC 5V/2A, Max.10W, Type-C port	DC 5V/2A, Max.10W, Type-C port	DC 5V/2A, Max.10W, Type-C port
GENERAL			
Working Temperature	-30°C to 55°C (-22°F to 131°F)	-30°C to 55°C (-22°F to 131°F)	-30°C to 55°C (-22°F to 131°F)
Storage Temperature (w/o batteries)	-40°C to 70°C (-40°F to 158°F)	-40°C to 70°C (-40°F to 158°F)	-40°C to 70°C (-40°F to 158°F)
Working Humidity	< 90%	< 90%	< 90%
Protection Level	IP67	IP67	IP67
Mounting	1/4"-20 UNC	1/4"-20 UNC	1/4"-20 UNC
Cable Output	USB Type-C port	USB Type-C port	USB Type-C port
Dimensions (L×W×H)	217 × 155 × 87 mm (8.5 × 6.1 × 3.5 in)	217 × 155 × 88 mm (8.5 × 6.1 × 3.5 in)	230 × 155 × 88 mm (9.0 × 6.65 × 3.5 in)
Weight	1.12 kg (2.5 lb)	1.12 kg (2.5 lb)	1.45 kg (3.2 lb)

**All data is subject to change without notice.*



AGM Global Vision, LLC

MAIN OFFICE

173 West Main Street

PO Box 962

Springerville, AZ 85938

USA

Tel. +1.928.333.4300

info@agmglobalvision.com

www.agmglobalvision.com

EUROPEAN OFFICE

#6 Andrey Lyapchev Blvd

Sofia, P.C. 1756

Bulgaria

Tel. +35.988.560.0326

info@agmglobalvision.eu

www.agmglobalvision.eu

DOWNLOAD AGM CONNECT APP:



Google Play Store



Apple App Store

AGMglobalvision.com