

Rattler V²

THERMAL IMAGING RIFLE SCOPE

© 2024 AGM Global Vision, LLC. All rights reserved.

This documentation is subject to change without notice.

No parts of this manual, in whole or in part, may be copied, photocopied, translated, or transmitted by any electronic medium or in machine-readable form without the prior written permission of AGM Global Vision, LLC.

Approved for public release, distribution unlimited.

If you have questions that are not covered in this manual, or need service, contact AGM Global Vision customer support for additional information prior to returning a product.

AGM Global Vision, LLC

173 West Main Street

PO Box 962

Springerville, AZ 85938

Tel. 928.333.4300

support@agmglobalvision.com

www.agmglobalvision.com

EXPORT INFORMATION

Buyer acknowledges that all products supplied by AGM Global Vision, LLC are subject to U.S. export control laws, including, but not limited to, the Export Administration Regulations, the International Traffic in Arms Regulations, the International Economic Emergency Powers Act, and various U.S. embargoes and sanctions. AGM Global Vision products may not be exported, re-exported, or transferred contrary to U.S. export control laws. In particular, AGM Global Vision products may not be exported, re-exported, or transferred to prohibited countries, individuals, organizations, or entities, including but not limited to those individuals and entities listed on the List of Specially Designated Nationals and Blocked Persons administered or maintained by the U.S. Office of Foreign Assets Control ("OFAC"), the various lists maintained by the Bureau of Industry and Security of the Department of Commerce, and the U.S. State Department and Buyer represents and warrants that neither Buyer nor any of its officers, directors, or employees are on such lists. Distribution or resale by Buyer to such countries, individuals, organizations, or entities is expressly prohibited. Buyer has and will maintain a positive process to ensure compliance with this Section.

FCC INFORMATION

Please take attention that changes or modification not expressly approved by the party responsible for compliance could void the user's authority to operate the equipment.



This equipment complies with FCC/IC RSS-102 radiation exposure limits set forth for an uncontrolled environment.

FCC compliance: This product has been tested and found to comply with the limits for a Class B digital device, pursuant to Part 15 of the FCC Rules. These limits are designed to provide reasonable protection against harmful interference in a residential installation. This product generates, uses, and can radiate radio frequency energy and, if not installed and used in accordance with the instructions, may cause harmful interference to radio communications. However, there is no guarantee that interference will not occur in a particular installation. If this product does cause harmful interference to radio or television reception, which can be determined by turning the equipment off and on, the user is encouraged to try to correct the interference by one or more of the following measures:

- Reorient or relocate the receiving antenna.
- Increase the separation between the equipment and receiver.
- Connect the equipment into an outlet on a circuit different from that to which the receiver is connected.
- Consult the dealer or an experienced radio/TV technician for help.

FCC Conditions

This device complies with part 15 of the FCC Rules. Operation is subject to the following two conditions:

1. This device may not cause harmful interference.
2. This device must accept any interference received, including interference that may cause undesired operation.

EU CONFORMITY STATEMENT



This product and - if applicable - the supplied accessories too are marked with "CE" and comply therefore with the applicable harmonized European standards listed under the EMC Directive 2014/30/EU, the RoHS Directive 2011/65/EU



2012/19/EU (WEEE directive): Products marked with this symbol cannot be disposed of as unsorted municipal waste in the European Union. For proper recycling, return this product to your local supplier upon the purchase of equivalent new equipment, or dispose of it at designated collection points. For more information see: www.recyclethis.info



2006/66/EC (battery directive): This product contains a battery that cannot be disposed of as unsorted municipal waste in the European Union. See the product documentation for specific battery information. The battery is marked with this symbol, which may include lettering to indicate cadmium (Cd), lead (Pb), or mercury (Hg). For proper recycling, return the battery to your supplier or to a designated collection point. For more information see: www.recyclethis.info

INDUSTRY CANADA ICES-003 COMPLIANCE

This device meets the CAN ICES-3 (B)/NMB-3(B) standards requirements.

LIST OF CONTENTS

| TITLE | PAGE |
|--|-----------|
| Safety Summary | 5 |
| 1. GENERAL INFORMATION | 7 |
| 1.1 System Description | 7 |
| 1.2 Optional Equipment | 8 |
| 1.3 Key Features | 8 |
| 2. OPERATING INSTRUCTIONS | 9 |
| 2.1. Basic Operations | 9 |
| 2.2 Main Function | 15 |
| 2.3 Client Software Introduction | 26 |
| 3. MAINTENANCE | 28 |
| 3.1 Maintenance | 28 |
| 3.2 Troubleshooting | 29 |
| 4. WARRANTY INFORMATION | 30 |
| 4.1 Warranty Information and Registration | 30 |
| 5. SPECIFICATIONS | 32 |
| 5.1 RattlerV ² 256 Specifications | 32 |
| 5.2 RattlerV ² 384 Specifications | 33 |
| 5.3 RattlerV ² 640 Specifications | 34 |
| 5.4 RattlerV ² Reticle Parameters | 36 |

SAFETY SUMMARY

- Read and follow all instructions
- Read all warnings
- Only use the attachments/accessories specified by the manufacturer
- All service must be provided by the manufacturer

WARNINGS:

- **This product contains natural rubber latex, which may cause potentially fatal allergic reactions! If you are allergic to latex, it is important that you strictly avoid exposure to products that contain it.**
- Always make sure your firearm is unloaded before you place the scope on the firearm. Reconfirm that the chamber is empty if you stop the procedure then resume later. Safe handling rules should be followed at all times.
- If a scope is mounted too far to the rear, the eyepiece can injure the shooter's brow. Shooting at an uphill angle also increases this hazard because it shortens the distance between the brow and the rear of the scope. For this reason, AGM scopes are engineered to provide generous eye relief. Therefore, when mounting your scope, we recommend positioning it as far forward in the mounts as possible to take full advantage of this generous eye relief. With hard-recoiling rifles, serious injury or even death can result from eyepiece impact with the shooter during the recoil process when discharging the firearm. Be certain that your installation provides sufficient eye relief for the recoil generated by your rifle before shooting the firearm.

NOTE: Give special attention to this warning when shooting uphill and/or from a prone position. These shooting conditions can dramatically reduce eye relief. PLEASE maintain maximum eye relief when shooting heavy recoiling and/or magnum firearms. THE USER ASSUMES ALL RESPONSIBILITY AND LIABILITY FOR HAVING THE AGM RIFLE SCOPE PROPERLY MOUNTED TO A FIREARM AND USING THE AGM RIFLE SCOPE PROPERLY. ALWAYS CHECK THE CONDITION OF YOUR MOUNTING SYSTEM PRIOR TO USING YOUR FIREARM.

- Proper usage of the device is crucial for safe operation, so make sure to carefully read this manual.
- If the device was left in storage for a longer period of time, before use, check its functionality.
- Disassembling of the device is prohibited, except in authorized repair centers.
- The external optical surfaces should be clean at all times. Touching the optical surfaces with bare hands is not recommended.
- Sand and sea water can damage the optical coatings.
- Do not point the device directly at the sun.
- Thermal imagery is highly dependent on different scenery and atmospheric conditions. The same scenery may differ slightly in its appearance to the user, based on the time of day or night the optic is being used. This is the result of the level of heat absorption of different objects, which will vary based on the sun's placement in the sky at the time of use. The contrast of live animals will be more evident depending on the difference in surrounding air temperature and humidity levels.

- It is always recommended to store the unit with batteries removed, when not in use. Recharging the batteries every 2-3 months will help to extend their charging reliability.
- It is recommended to store the device with the lens cap closed at all times.
- Occasionally, extreme temperature shifts may causing condensation to form on the outer germanium lens. In this scenario, use a soft cloth to gently wipe the lens clean. As the unit becomes acclimates to the outer temperature, condensation should dissipate.

NOTES:

- The detector spectral band provides better visibility through smoke, dust, rain, smog, etc.
- Infrared radiation does not travel through glass. As a result, the rifle scope does not detect objects if they are behind glass windows or other barriers.

1 GENERAL INFORMATION

1.1 SYSTEM DESCRIPTION

The AGM RattlerV² thermal rifle scopes feature an advanced twelve-micron thermal detector, boasting sub-20 millikelvin sensitivity rating, supplying it with what is now the most sensitive temperature rating in its class. This increase in temperature sensitivity ensures a clear image even in some of the most challenging conditions, including: complete darkness, fog, smoke, dust, rain and snow. Although the RattlerV²'s were developed primarily for hunters and shooters, its compact housing and quick detach mounting system make it versatile enough for general outdoors enthusiasts, search & rescue teams, law enforcement and other first responder applications.

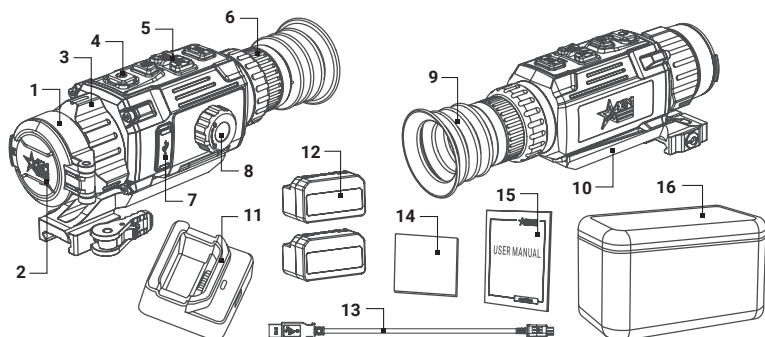

FIGURE 1-1. MAIN PARTS AND COMPONENTS

TABLE 1-1. MAIN PARTS AND COMPONENTS

| ITEM | DESCRIPTION |
|------|----------------------|
| 1 | Objective Lens |
| 2 | Objective Lens Cover |
| 3 | Objective Focus Ring |
| 4 | Power Button |
| 5 | Operation Buttons |
| 6 | Eyepiece Focus Ring |
| 7 | USB Type-C Interface |
| 8 | Battery Compartment |

| ITEM | DESCRIPTION |
|------|--------------------------|
| 9 | Eyecup |
| 10 | Mount |
| 11 | Charger |
| 12 | Rechargeable Battery (2) |
| 13 | USB Cable |
| 14 | Lens Tissue |
| 15 | User Manual |
| 16 | Carrying Case |

The AGM RattlerV² comes equipped with a replaceable and rechargeable Li-Ion battery, offering an impressive 9 - 11.5 (depending on model) hours of battery life. For extended usage, you can easily connect an external 5V power bank (battery pack) via the USB-C connector, significantly extending the device's operational time, which will vary depending on the power banks capacity. Additionally, the scope includes an onboard Wi-Fi module that allows for seamless live video streaming and recording of videos/images through a dedicated mobile application (AGM Connect).

1.2 OPTIONAL EQUIPMENT

Optional items are shown in Figure 1-2 and listed in Table 1-2.

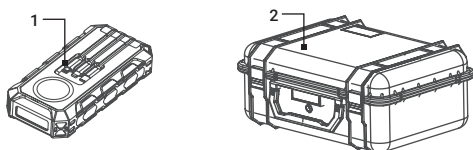

FIGURE 1-2. OPTIONAL EQUIPMENT

TABLE 1-2. OPTIONAL EQUIPMENT

| ITEM | DESCRIPTION | PART NO. |
|------|--------------------------------------|-----------|
| 1 | AGM Power Bank 30,000 mAh | 6628XPB31 |
| 2 | Hard Case for Storage/Transportation | 6610HCS1 |

1.3 KEY FEATURES

- 12µm thermal detector
- High thermal sensitivity
- Fast 50 Hz imaging
- High resolution OLED display
- Adjustable color palettes
- Various reticle types and colors
- 1x, 2x, 4x and 8x digital zoom
- On-board video/audio recording and image capture
- Built-in EMMC storage (16 GB)
- Shot Activated Recording (SAR)
- Wi-Fi data transmission
- Stadiametric rangefinder
- Standby mode
- 9 - 11.5 hours of battery life (depending on model)
- External power supply compatibility
- Waterproof & shockproof

2 OPERATING INSTRUCTIONS

2.1. BASIC OPERATIONS

2.1.1 UNPACKING

The following steps must be completed prior to each use.

1. Open the carrying case, remove the device, and verify that all components are included.
2. Inspect the device for any signs of damage to the optical surfaces, body, eyecup, operation buttons, etc. Ensure that all optical surfaces are clean and ready for use. Once the diopter is set, all focusing of the image upon use of the digital zoom will occur via the lens focus knob, which is the rotating knob closest to the objective lens of the scope.

2.1.2 BATTERY INSTRUCTION

1. The device supports a removable NE-4400 Li-Ion rechargeable battery. The battery voltage is 3.6V and the capacity is 4.4Ah (15.84 Wh). The battery charging voltage is limited to 4.2V.
2. Before first use, charge the battery to full capacity using the NE-Charger.
3. Please purchase the NE-4400 batteries recommended by the manufacturer if necessary.
4. Be sure to remove the battery when storing the device for long periods of time.

2.1.3 BATTERY INSTALLATION

CAUTION:

Verify that the device is turned off before removing the battery.

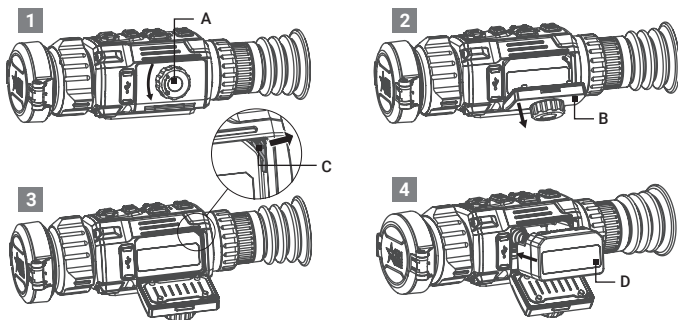

FIGURE 2-1. BATTERY INSTALLATION

To install the battery (refer to Figure 2-1):

1. Turn the battery cover knob (A) counter clockwise and then open the battery cover (B).
2. Push the red latch (C) aside (as the arrow shows), and release the battery.
3. Insert the battery (D) into the battery compartment. The latch locks the battery in place when the battery is fully inserted.
4. Once the battery is locked into place, close the battery door until a “click” is heard, or felt. This means the internal battery door lever is engaged with the housing to secure the battery door in place. Turn the device on. The internal display will show the level of charge via the battery indicator symbol.

When the device is on a battery charge level is displayed on the status bar.

2.1.4 CONTROL BUTTONS

The Rattler controls are shown in Figure 2-2 and are defined in Table 2-1.

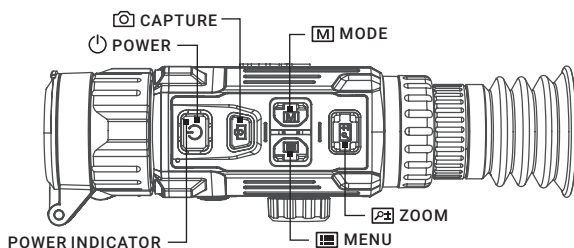







FIGURE 2-2. CONTROL BUTTONS

Each button is responsible for some functions selected by short press or long press of the button. Pushing a button for 3+ second is considered “long press/hold.”

TABLE 2-1. BUTTON FUNCTIONS



| BUTTON | FUNCTIONS |
|---|--|
|  POWER | Press: Standby Mode/Wake Up Device Hold: Power On/Off |
|  MENU | <u>NON-MENU MODE</u> Press: Enter the Quick Menu Hold: Enter the Main Menu <u>MENU MODE</u> Press: Confirm/Set Parameters Hold: Exit the Menu |
|  MODE | Press: Palette Switching Hold: Correct Non-uniformity of Display (FFC) |
|  CAPTURE | Press: Image Capture Hold: Start/Stop Video Recording |
|  ZOOM | Press: Switching Digital Zoom Hold: Enable/Disable PIP mode |

2.1.5 POWER ON AND OFF

Power On

With the battery installed, press and hold the POWER button  to turn on the device. The red LED indicator on the POWER button will light up.

NOTE

See the battery icon on the device display to check the battery charge. Icon  means the battery is fully charged, and icon  means that the battery is low. When the low power note shows, replace the batteries.

Power Off

When the device is turned on, hold the POWER button  to turn off the device.

Auto Power Off

In the "Auto Power Off" menu you can set the time for the automatic shutdown of the device as required (OFF / 15 min / 30 min / 45 min).

The Auto Power Off function starts countdown when Standby mode enable. The auto power off countdown is disabled when the device wakes up from standby. The countdown will be restarted when the device is put into standby mode again.

2.1.6 STANDBY MODE

Standby mode is used to save battery power. In this mode, some power-consuming features such as the display, network hardware, or internal storage will be temporarily disabled.

In the view mode, press the POWER button . After a few seconds, the display will turn off. Press the POWER button  again to exit the Standby mode.

2.1.7 VIEWING THE THERMAL IMAGE

1. Power on the rifle scope.
2. Bring the scope to your eye and make sure the eyecup covers your eye.
3. Use the eyepiece focus ring (rotating ring closest to your eye) to diopter adjustment. Rotate the ring to keep the on-screen menu and reticle are crisp and sharp. Once completed, diopter adjustment will no longer be needed again until the device is used by a new user.
4. After setting the diopters, all image focusing when using the scope at various distances will be done using the lens focusing ring.

NOTE:

You must perform the focus adjustment before any further use of the scope.

5. Set palette, brightness, contrast, tone, and scene mode to display the best image effect.

2.1.8 ON-SCREEN DISPLAY

On-screen interface displays the main menu items and device status indicators.

Hold the MENU button  in the view mode to display or hide the menu.

Press the MENU button  in the view mode to display or hide the On-Screen Display (OSD) information.

When OSD is on, the information of Wi-Fi hotspot activation, magnification, storage memory status, battery status, time and date displays on the screen.

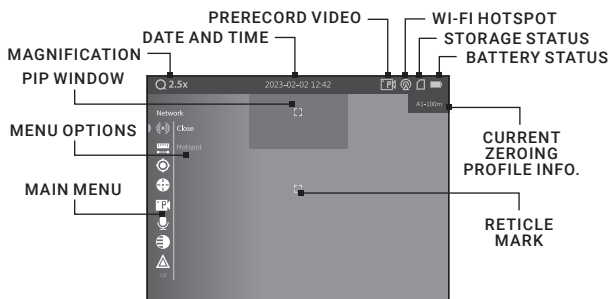

FIGURE 2-3. ON-SCREEN DISPLAY

2.1.9 PALETTE SETTINGS

You can select different palettes to display the same scene in different effects. Press the MODE button **[M]** in the view mode to switch palettes.

TABLE 2-2. PALETTE SETTINGS

| PALETTE | DESCRIPTION |
|-----------|--|
| WHITE HOT | The hot part is displayed in white. The higher the temperature, the lighter the color. |
| BLACK HOT | The hot part is displayed in black. The higher the temperature, the darker the color. |
| FUSION | The hot part is displayed in white. From high temperature to low temperature, the image is colored in from white, yellow, red, pink to purple. |
| RED HOT | The hottest part is displayed in red, the rest of the image will be flushed out in shades of gray. |

2.1.10 DIGITAL ZOOM

Press the ZOOM button **[Z]** in the view mode to switch between 1x, 2x, 4x and 8x digital zoom. The image magnification value is displayed on the screen:

- RattlerV² 19-256: 2.5x, 5x, 10x, 20x
- RattlerV² 25-256: 3.5x, 7x, 14x, 28x
- RattlerV² 25-384: 2x, 4x, 8x, 16x
- RattlerV² 35-384: 3x, 6x, 12x, 24x
- RattlerV² 35-640: 2x, 4x, 8x, 16x
- RattlerV² 50-640: 2.5x, 5x, 10x, 20x

2.1.11 PICTURE IN PICTURE

In the live view you can enable or disable the Picture-in-Picture (PIP) function by holding the ZOOM button **[Z]**.

The PIP window at the top of the screen displays the details of central part of the image at 2x zoom.

NOTE:

- When the reticle is enabled, the PIP view shows the details centered around the crosshair. When the reticle is not enabled, the PIP view shows the details within the central section of the display.
- If digital zoom is enabled, the PIP view also zooms. If the digital zoom ratio exceeds 4, the PIP does not zoom.

2.1.12 VIDEO RECORDING AND IMAGE CAPTURE

Video Recording

Hold the CAPTURE button  in the view mode and start recording. In the upper left corner, the recording time displays.

Hold the CAPTURE button  again to stop recording.

Image Capture

Press the CAPTURE button  in the view mode, to capture the image.

NOTE:

- When captured, the image freezes for 1 second and a prompt shows on the display.
- For exporting captured images, refer to File Export.

2.1.13 CONNECTING THE DEVICE

1. Open the cable interface cover.
2. Connect the device and power adapter with a USB Type-C cable to charge the battery while installed within the device. You can also supply power to the device using an external power system through the USB port. Alternatively, you may also connect the device to your computer using the included USB cable to copy/delete files. Or, your image and video content can be managed through the AGM Connect phone application.

The LED indicator near the USB port indicates the following statuses:

Solid Red: the device is properly charged.

Solid Green: the device is fully charged.

Flashing Red & Green: the battery is not installed and the device is powered by an external power supply / an error has occurred.

Off: device is not charged.

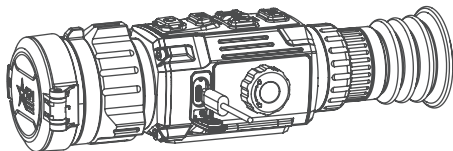

FIGURE 2-4. CABLE INTERFACE

2.1.14 FILE EXPORT

1. Before connecting the thermal rifle scope to a computer, please make sure that the Wi-Fi function of the rifle scope is disabled.
2. Connect the thermal rifle scope to your PC with USB cable and open the detected disk.

3. The directory is named by the current date. Enter DCIM > "Date" to view the videos and snapshots.
 - Select and copy the videos to PC and play the file with the player.
 - Select and copy the snapshots to PC and view the files.
4. Disconnect the device from your PC.

NOTE:

- The device displays images when you connect it to PC. But functions such as recording, capturing and hot spot are disabled.
- When you connect the device to PC for the first time, it installs the driver automatically.

2.1.15 INSTALLING THE RATTLER ON A PICATINNY/WEAVER RAIL

WARNING:

Always make sure your firearm is unloaded before you place the scope on the firearm. Reconfirm that the chamber is empty if you stop the procedure then resume later. Safe firearms handling rules should be followed at all times.

The RattlerV² comes with a Picatinny/Weaver mount. The mount is secured to the scope with two screws. The recommended tightening torque for the fixing screws is 4-5.3 Nm (5.44-7.2 ft lb).

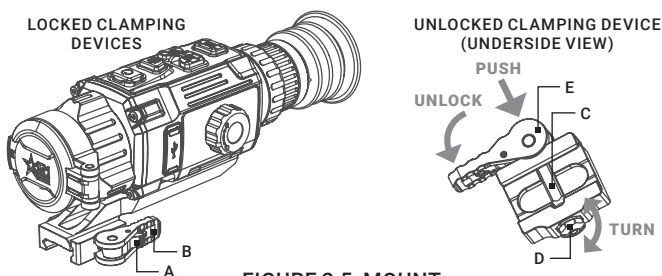

FIGURE 2-5. MOUNT

To install the Rattler on a Picatinny/Weaver rail, perform the following:

1. Unlock the clamping device of the scope mount by pushing down on the lever holder (A) and unlocking the lever (B).
2. Install the scope on the Picatinny/ Weaver rail so that the stop (C) slides into the transverse slot on the rail.
3. Affix the scope to the rail by locking the lever (B).
4. Verify that the clamping device is firmly holding the Rattler. If necessary, adjust the clamping device's lever-cam lock as detailed in part 2.1.16.

2.1.16 CLAMPING DEVICE ADJUSTMENT

To adjust the mount's clamping device, do the following:

1. Remove the RattlerV² from the rifle.
2. With the clamping device unlocked (as shown in Figure 2-5), push the cam (E) towards the arrow, which will cause the nut (D) to slide out of its hole.

- To tighten/ loosen the clamping device, push down on the cam (E) and turn the nut (D) CW/ CCW respectively, in one-two increments (see note below). Much like when the cam (E) is released, backward-moving spring will cause the nut (D) to slide back into its hole.

NOTE:

The eight-sided nut of the mount lever-cam lock will only fit into their hole if turned in one of the discrete positions, using increments equal to 360°/8.









- Verify that the adjusted lever-cam lock securely holds the mounting rail.

2.2 MAIN FUNCTIONS









2.2.1 QUICK MENU

In the live view mode, press  to show the Quick Menu. This menu allows you to adjust the brightness and contrast settings of the thermal image.

2.2.2 BRIGHTNESS ADJUSTMENT

- Press the MENU button  to show the Quick Menu.
- Press  or  button to select  **Brightness** menu item and press the MENU button  to confirm.
- Press  or  button to adjust the brightness. You can select one of ten levels of the brightness to adjust the image lighter or darker.
- Hold the MENU button  to exit a menu.

2.2.3 CONTRAST ADJUSTMENT

- Press the MENU button  to show the Quick Menu.
- Press  or  button to select  **Contrast** menu item and press the MENU button  to confirm.
- Press  or  button to adjust the image contrast. You can select one of ten levels of the contrast.
- Hold the MENU button  to exit a menu.

2.2.4 MAIN MENU OPERATION

When the device powers on, hold the MENU button  in the view mode to display the Main Menu.

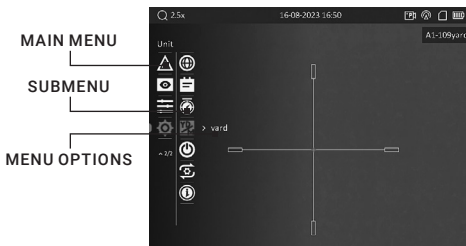





















FIGURE 2-6. MAIN MENU

Press  or  buttons to move between menu items. The active element is highlighted. Press the MENU button  to select menu item or change an option.

Hold the MENU button  to save settings and exit the menu.

TABLE 2-3. MENU FUNCTIONS

| MENU ITEM | SYMBOL | OPTION | FUNCTION |
|-------------------------|---|---|---|
| NETWORK |  | Close / Hotspot | Enables or disables the Wi-Fi hotspot. |
| MEASURE |  | Target: Deer, Grey Wolf, Brown Bear, and Custom | Measures the distance between the target and the observation position. |
| HOT TRACKING |  | OFF / ON | Enables or disables hot spot mark (marking the spot of highest temperature). |
| ZEROING PROFILES |  | 5 Profiles (A/B/C/D/E) | Zeroing profile selection with user saved zeroing settings. |
| ZEROING |  | Zeroing Menu: | |
| Zeroing |  | OFF / 1 / 2 / 3 / 4 / 5 | Zeroing settings selection or disable reticle. |
| Distance |  | Distance | Setting the distance to the target. |
| Type |  | 10 Reticle Type | Setting the reticle type. |
| Color |  | 4 Reticle Colors | Setting the reticle color (black, white, red, green) |
| Zoom |  | 1x / 2x / 4x / 8x | Digital Zoom setting. |
| Freeze Screen |  | OFF / ON | Image freeze. |
| X/Y Axis |  | X / Y | Switching the X and Y axes of correction. |
| PRERECORD |  | OFF / ON | Device can automatically record the 7 seconds before and after the recoil activation. |
| AUDIO |  | OFF / ON | Enable or disable Audio. |
| TONE |  | Cold / Warm | Switch between the Cold mode and Warm mode. |
| SHARPNESS |  | 5 Levels of Sharpness | Adjusts the image sharpness. |
| SCENE MODE |  | Recognition / Jungle | Switch between the Recognition mode and Jungle mode. |

| MENU ITEM | SYMBOL | OPTION | FUNCTION |
|--------------------------|--------|--------------------------------|---|
| FUNCTION SETTINGS | | Function Settings Menu: | |
| OSD | | OSD / Time / Date | Enables or disables OSD, time, date. |
| Image Calib. | | Auto / Semi-Auto / Manual | Selecting the Flat Field Correction (FFC) mode. |
| DPC | | Axis: N/X/Y | Correction of dead pixel manually. |
| Burn Prevention | | OFF / ON | Enables or disables the Burn Prevention function. |
| GENERAL SETTINGS | | General Settings Menu: | |
| Language | | 22 Languages | Choice of interface language. |
| Date | | Month/Day/Year | Date setting. |
| Time | | 12 / 24 hour | Time setting. |
| Unit | | yard / m | Sets the distance unit. |
| Auto Power Off | | OFF / 15 min / 30min / 45min | Setting the automatic shutdown time. |
| Restore | | --- | Restoring the default device settings. |
| Version | | --- | Firmware version and serial number. |

2.2.5 NETWORK CONFIGURATION

Connect your phone to the Wi-Fi hotspot of the rifle scope, you can configure the parameters and realize functions of the device.

1. Hold the MENU button to show the menu.
2. Press or button to select **Network** menu item and press the MENU button to enable or disable Wi-Fi hotspot.
3. Hold the MENU button to exit a menu.

Open the AGM Connect APP and connect your phone with the device (refer to Section 2.3). You can view the interface of rifle scope on your phone.

NOTE:

When the power is less than 15%, the Wi-Fi hotspot function will be turned off automatically.

2.2.6 DISTANCE MEASUREMENT

NOTE:

When measuring the distance, keep your hand and the position steady. Otherwise, the accuracy may be affected.

The device can measure the distance between the target and the observer's position.

















1. Hold the MENU button  to show the menu.
2. Press  or  button to select  Measure menu item and press the MENU button  to enter the distance measurement mode.
3. Press  button to enter the target setting interface.
 - 1) Press  or  to select the target from Wolf, Bear, Deer, and Custom.
 - 2) Press the MENU button  to set the target height. Press  or  buttons to change the number. Each target height preset can be modified from 0.1 to 9.9 m. Press the MENU button  to confirm.
 - 3) Hold the MENU button  to exit target setting.



FIGURE 2-7. DISTANCE MEASUREMENT







4. Align the center of the top mark with the top edge of the target. Press the MENU button . The top mark blinks and then changes to the bottom mark.
5. Align the center of the bottom mark with the bottom edge of the target. Press the MENU button . The bottom mark blinks and then disappears.
6. The right top of the image displays the distance measurement result and the height of the target.

NOTE:

Go to distance measurement interface, and press  button to view the result of the previous measuring target.

2.2.7 HOT TRACKING









The device can detect the highest temperature spot in the scene and mark it on display.

1. Hold the MENU button  to show the menu.
2. Press  or  button to select  Hot Tracking menu item and press the MENU button  to enable/disable hot spot mark (marking the spot of highest temperature).
3. Hold the MENU button  to exit a menu.

When the hot spot mark is enabled, the green cross mark  displays in the spot of the highest temperature. When the scene changes, the green mark moves.

2.2.8 ZEROING PROFILES

The user can customize and save five profiles with different reticle settings. In each profile, you can configure up to five types of reticle, firing distances and reticle corrections.

1. Hold the MENU button  to show the menu.
2. Press  or  button to select  Zeroing Profiles menu item and press the MENU button  to confirm.
3. Press  or  button to switch the zeroing profile.
4. Hold the MENU button  to exit a menu.

The right top of the image displays the reticle information. For example, A1-50m means you are using the Zeroing No. 1 in the Profile A, and the set range is 50 m.

















NOTE:

There are 5 zeroing profiles in total, and you can configure 5 reticles, zeroing distances and corrections in each zeroing profile.

2.2.9 ZEROING





You can select a reticle in the current zeroing profile, and set parameters such as reticle type, color, and boresight correction (coordinates) for the reticle.

Select a zeroing profile initially (refer to 2.2.8).

1. Hold the MENU button  to show the menu.
2. Press  or  button to select  Zeroing menu item and press the MENU button  to enter the zeroing setting interface. Press  or  buttons to move between submenu and options.
3. Press  or  to select  Zeroing No. You can select OFF to disable the reticle.
4. Set reticle type (for parameters of all built-in reticles, see part 5.4).
 - 1) In the zeroing setting interface press  or  button to select  Type submenu and press the MENU button  to confirm.
 - 2) Press  or  button to select a reticle type and press the MENU button  to confirm.

NOTE:

The scale intervals of the Reticle 4 changes synchronously under the current digital zoom.

5. Set reticle color.
 - 1) In the zeroing setting interface press  or  button to select  Color submenu and press the MENU button  to confirm.
 - 2) Press  or  button to select black, white, red or green color of reticle and press the MENU button  to confirm.

NOTE:

In Black Hot mode and White Hot mode, if you set the reticle color as white or black, the reticle colors can be automatically inverted depends on thermal image around the reticle.





6. (Optional) Repeat 3 to 5 to set type and color for other reticles in this profile.
7. Hold the MENU button  to save and exit.

2.2.10 BORESIGHTING

Like any daytime rifle scope or red dot, sighting in is both similar, and simplified. The RattlerV² comes with a one-shot zeroing system, which makes initial sighting in quick and painless.

Set the target to the selected zeroing distance. We recommend 50-100 yards initially. Select a zeroing profile (refer to 2.2.8). You can use different zeroing profiles if you want to use the optic on a different rifles.

Align the reticle with the center of the target and shoot. If the point of impact does not coincide with the aiming point, correct the reticle.

1. Hold the MENU button  to show the menu.
2. Press  or  button to select  Zeroing menu item and press the MENU button  to enter the zeroing setting interface.

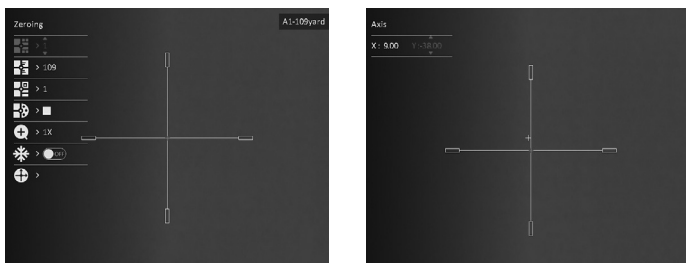

























FIGURE 2-8. BORESIGHTING

3. Press  or  button to select  Zeroing number you want to correct and press the MENU button  to confirm.
4. Set the distance to the target:
 - 1) In the zeroing setting interface press  or  button to select  Distance and press the MENU button  to confirm.
 - 2) Press the MENU button  to select the digit you want to change (color of selected digit will be changed to the red) and press the MENU button  to confirm.
 - 3) Press  or  button to change the number and press the MENU button  to confirm.
5. (Optional) Press  or  button to select  Zoom option, and press  or  button to enlarge the image until the target position is clear enough. Press the MENU button  to confirm.

NOTE:









We'd suggest zeroing in at 1x, or your true optical base magnification, or 2x zoom (double your optical magnification) as these options are less pixelated and should provide for easier adjustments.

6. (Optional) Press  or  button to select  Freeze Screen option, and press the MENU button  to enable the Freeze Screen function.

NOTE:

When enabling the Freeze Screen function, you can adjust the position of the cursor on a frozen image. This feature helps prevent image flutter and eliminates the need to hold the rifle scope steady in order to make your windage and elevation adjustments on screen.

7. Two crosshairs are displayed on the screen. The big one is reticle crosshair, and the small one is reference small crosshair. Reference crosshair will appear in the centre of the display. Zero the scope by moving the reticle on the screen. Set the reticle position:

- 1) Aim the big reticle at the center of target.
- 2) Press  or  button to select  X/Y Axis and press the MENU button  to confirm.
- 3) Press  or  button to select X or Y axis and press the MENU button  to confirm.
- 4) Press  or  buttons to move reticle left and right (if X axis is selected) or to move reticle up and down (if Y axis is selected).

Holding the reference small crosshair at the aiming point (center of the target) and move the reticle until it is aligned with the point of impact. The coordinates show the current position of the reticle.

TABLE 2-4. BORESIGHT CORRECTION

| MODEL | ADJUSTMENT VALUE | RETICLE OFFSET | BORESIGHT INCREMENT |
|-----------------------------------|------------------|----------------|---|
| RattlerV ² 19-256 | 1 click | 1 pixel | 0.16 mil / 0.54 MOA / 1.6 cm at 100 m distance / 0.56 in at 100 yd distance |
| RattlerV ² 25-256 | 1 click | 1 pixel | 0.12 mil / 0.41 MOA / 1.2 cm at 100 m distance / 0.43 in at 100 yd distance |
| RattlerV ² 25-384 | 1 click | 1 pixel | 0.18 mil / 0.62 MOA / 1.8 cm at 100 m distance / 0.65 in at 100 yd distance |
| RattlerV ² 35-384 | 1 click | 1 pixel | 0.13 mil / 0.44 MOA / 1.3 cm at 100 m distance / 0.46 in at 100 yd distance |
| RattlerV ² TS35-640 | 1 click | 1 pixel | 0.21 mil / 0.73 MOA / 2.1 cm at 100 m distance / 0.76 in at 100 yd distance |
| RattlerV ² TS50-640 | 1 click | 1 pixel | 0.15 mil / 0.51 MOA / 1.5 cm at 100 m distance / 0.53 in at 100 yd distance |







8. (Optional) Repeat 3 to 7 to set the position for other reticles in this profile. You can place up to five zeroes at different distances within the same profile (useful for certain calibers with highly fluctuating trajectories between 50 and 250 yards).

9. Hold the MENU button  to exit. The window "Save the parameters?" will appear.

- OK: Save the settings and exit.
- CANCEL: Exit without saving the settings.

2.2.11 PRERECORD VIDEO

After enabling the Shot Activated Recording (SAR) function, the device will automatically start recording 7 seconds before the recoil-activation and end recording 7 seconds after the recoil-activation.







1. Hold the MENU button  to show the menu.
2. Press  or  button to select  Prerecord menu item.
3. Press the button  to switch ON/OFF SAR function.
4. Hold the MENU button  to exit a menu.

NOTE:

For exporting recorded files, refer to Export Files (part 2.1.14).









2.2.12 AUDIO RECORDING SETTING

The Audio function allows you to record sound along with video. If there is too much noise when recording, this function can be disabled.

1. Hold the MENU button  to show the menu.
2. Press  or  button to select  Audio menu item, and press the MENU button  to enable or disable this function.
3. Hold the MENU button  to exit a menu.









2.2.13 IMAGE TONE SETTING

This function allows you to change the tone of thermal image to warm or cold.

1. Hold the MENU button  to show the menu.
2. Press  or  button to select  Tone menu item and press the MENU button  to confirm.
3. Press  or  button to select Warm or Cold tone.
4. Hold the MENU button  to exit a menu.







2.2.14 SHARPNESS SETTING

This function allows you to adjust the sharpness of the thermal image.

1. Hold the MENU button  to show the menu.
2. Press  or  button to select  Sharpness menu item and press the MENU button  to confirm.
3. Press  or  button to adjust the image sharpness.
4. Hold the MENU button  to exit a menu.

2.2.15 SCENE MODE

You can select proper Scene Mode according to environment temperature to improve the display effect.

1. Hold the MENU button  to show the menu.
2. Press  or  button to select  Scene Mode menu item and press the MENU button  to confirm.
3. Press  or  button to switch scene mode:













Recognition mode: improves an image so that the object edge is more distinct.

Jungle mode: is more suitable for hunting environment because of the highlight function of small objects.

4. Hold the MENU button  to exit a menu.











2.2.16 ON-SCREEN DISPLAY (OSD)

You can choose which OSD information to display in the live view user interface. Options include, wi-fi hotspot activation, current magnification, memory storage status, battery indicator status, time and date. These will appear at the top of the display interface when activated.

1. Hold the MENU button  to show the menu.
2. Press  or  button to select  **Function Settings** menu and press the MENU button  to confirm.
3. Press  or  button to select  **OSD** submenu and press the MENU button  to enter.
4. Press  or  button to select the **OSD, Time or Date**. Press the MENU button  to display or hide the necessary information.
5. Hold the MENU button  to exit a menu.

2.2.17 IMAGE CALIBRATION

The image calibration function performs what is known as the Flat Field Correction or FFC. This is required of all thermal devices. This can correct for non-uniformity of the display. During correction an internal shutter will be lowered in front of the thermal detector. A “click” sound will often be heard, and the image is momentarily interrupted for a split second. After this quick process the detector will be re-calibrated, and the image becomes more accurate. AGM recommends automatic when scanning for game or targets. However, we recommend going into the menu and changing to Manual correction mode when getting close making your shot. This will prevent any unwanted auto-correction occurring when tracking live game. This will help shooters in making ethical shot placements at all times.

1. Hold the MENU button  to show the menu.
2. Press  or  button to select  **Function Settings** menu and press the MENU button  to confirm.
3. Press  or  button to select  **Image Calib.** submenu and press the MENU button  to enter.
4. Press  or  button to switch the FFC mode.

Auto: The rifle scope performs FFC automatically when switching on or rebooting the camera.

Semi-Auto: Press the MODE button  in live view to correct the non-uniformity of display.

















Manual: Cover the lens cap, then press the MODE button  in live view to correct the non-uniformity of display.

5. Hold the MENU button  to exit a menu.

2.2.18 DEFECTIVE PIXELS CORRECTION











The Defective Pixel Correction (DPC) can help users repair the occasional deactivated pixel within the display. This is fairly common in thermal optics, which is why so many of these optics come equipped with a DPC feature. 1-3 dead pixels are usually easily repaired by the user. Anything over 3 that cannot be repaired, will open the unit up to an approved warranty repair by AGM at their facility.

Before you start switch the palette to White Hot mode.

1. Hold the MENU button  to show the menu.
2. Press  or  button to select  **Function Settings** menu and press the MENU button  to confirm.
3. Press  or  button to select  **DPC** submenu and press the MENU button  to enter.
4. Press  or  button to select the X or Y axis and press the MENU button  to confirm.
5. Press  or  button to set the coordinates until the cursor reaches the dead pixel.
6. Press the MENU button  to correct the dead pixel.
7. (Optional) Repeat 4 to 6 to correct the position for other dead pixels.
8. Hold the MENU button  to exit a menu.













2.2.19 BURN PREVENTION

This function can prevent damage to the thermal sensor from the sun or other high temperature bright light sources. When enabling this function, the shield will close until the environment turns to normal. This feature may be useful to help protect sensitive displays during extreme summer temperatures. AGM recommends all units be stored in room temperature whenever possible, as long periods of storage in extreme heat (such as inside a vehicle) may lead to issues with the display materials.















1. Hold the MENU button  to show the menu.
2. Press  or  button to select  **Function Settings** menu and press the MENU button  to confirm.
3. Press  or  button to select  **Burn Prevention** submenu and press the MENU button  to enable or disable the Burn Prevention function.
4. Hold the MENU button  to exit a menu.

2.2.20 LANGUAGE SETTING















You can select different languages of user interface.

1. Hold the MENU button  to show the menu.
2. Press  or  button to select  **General Settings** and press the MENU button  to confirm.
3. Press  or  button to select  **Language** submenu and press the MENU button  to enter.
4. Press  or  button to select the language as required and press the MENU button  to confirm.
5. Hold the MENU button  to exit a menu.

2.2.21 DATE SETTING











1. Hold the MENU button  to show the menu.
2. Press  or  button to select  **General Settings** and press the MENU button  to confirm.
3. Press  or  button to select  **Date** submenu and press the MENU button  to enter the configuration interface.
4. Press the MENU button  to select the month, day or year to be synchronized and press  or  button to change the number, then press the MENU button  again to finish the setting.
5. Hold the MENU button  to exit a menu.

2.2.22 TIME SETTING

1. Hold the MENU button  to show the menu.
2. Press  or  button to select  **General Settings** and press the MENU button  to confirm.
3. Press  or  button to select  **Time** submenu and press the MENU button  to enter the configuration interface.
4. Press the MENU button  to select the hour, minute, second to be synchronized and press  or  button to change the number, then press the MENU button  again to finish the setting.
5. Hold the MENU button  to exit a menu.













2.2.23 UNIT SETTING

You can set the unit (yards or meters) of measurement for distance.

1. Hold the MENU button  to show the menu.
2. Press  or  button to select  **General Settings** and press the MENU button  to confirm.
3. Press  or  button to select  **Unit** submenu and press the MENU button  to enter the configuration interface.
4. Press the MENU button  to select Yard or Meter.
5. Hold the MENU button  to exit a menu.









2.2.24 AUTO POWER OFF

You can set the time for the automatic shutdown of the device as required.

1. Hold the MENU button  to show the menu.
2. Press  or  button to select  **General Settings** and press the MENU button  to confirm.
3. Press  or  button to select  **Auto Power Off** submenu and press the MENU button  to enter the configuration interface.
4. Press  or  button to select OFF, 15 min, 30 min or 45 min and press the MENU button  to confirm.
5. Hold the MENU button  to exit a menu.









2.2.25 RESTORE DEVICE

You can reset the settings of device.

1. Hold the MENU button  to show the menu.
2. Press  or  button to select  **General Settings** and press the MENU button  to confirm.
3. Press  or  button to select  **Restore** and press the MENU button . The window "Initialize?" will appear.
 - **OK**: Restore the device to defaults.
 - **CANCEL**: Exit without changing the settings.

2.2.26 VERSION

You can view the device information such as firmware version and serial number.

1. Hold the MENU button  to show the menu.
2. Press  or  button to select  **General Settings** and press the MENU button  to confirm.
3. Press  or  button to select  **Version** item and press the MENU button  to confirm. The firmware version and serial number will be displayed.



2.3 CLIENT SOFTWARE INTRODUCTION

Search the AGM Connect software in App Store (iOS System) or Google Play™ (Android System) and install the application on your mobile phone. Turn on the Wi-Fi hotspot on the thermal device and then connect your phone to the hotspot.

- Hotspot Name: Wlan-<Serial No.>
- Hotspot Password: Last 9 digits of Serial Number of your thermal scope.

NOTE:

The device password is set by user at first activation. If the password was lost or forgotten, it can be reset. To reset a password perform the following steps:

1. When the thermal device is turned on, hold the MENU button  to activate the Main menu.
2. Select  **Restore** item in the General Settings menu and press the MENU button  to restore all parameters to default settings.
 1. Run the app and connect the phone or tablet with the device.
 2. If the device is inactivated, set the password and activate it. If the device is activated, enter the password to add it to the app.
 3. When the device is added, the live view can be seen. You can view the interface of the device on the software. User can change such image parameters as brightness, contrast, zoom, palettes directly via phone or tablet as well as record video on phone/tablet memory.

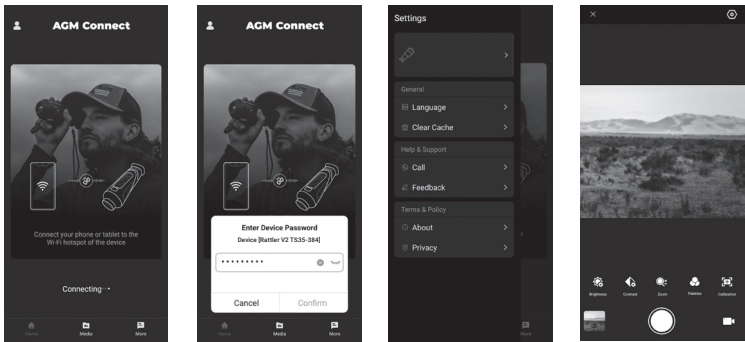

FIGURE 2-9. AGM CONNECT APPLICATION

3 MAINTENANCE

3.1 MAINTENANCE

3.1.1 CLEANING PROCEDURES

1. Gently brush off any dirt from the body of the device using a clean, soft cloth.
2. Moisten the cloth with fresh water and gently wipe down the external surfaces (except lenses).
3. Dry any wet surfaces (except lenses) using another dry, clean, soft cloth.
4. Using a lens brush, carefully remove all loose dirt from the lenses.
5. Use a high quality lens wipe to remove dirt or smudges from the lens and display window. Do not use abrasives or solvents to clean the housing, lens, or display window. Clean the glass surfaces using circular movements, starting from the center of the lens and moving out towards the edge.
6. Clean the accessories with a soft brush (or cloth) dampened with soap and water.

3.1.2 PREPARING FOR EXTENDED STORAGE

CAUTION:

Thoroughly dry each item before placing them into the storage case.

To prepare the rifle scope for extended storage:

1. Clean the rifle scope with a damp cloth to remove any dust, dirt or debris.
2. Remove the rechargeable battery.
3. Close the lens cap, and place items into their soft carrying case.

3.1.3 UPGRADE DEVICE

WARNING:

Please make sure the device is connected to the computer during the entire update process. Otherwise, it may cause unnecessary upgrade failure, firmware damage, etc.

1. Visit www.agmglobalvision.com/firmware website. Select your product, download the firmware update package to your PC and unzip it. Follow the detailed instructions on the website.
2. Connect the device to your PC with USB cable.
3. Turn on the device. Make sure the Wi-Fi hotspot function is disabled.
4. Open the detected disk (USB drive) in file manager program. Copy the unzipped digicap.dav file and paste it to the root directory of the device.

5. Turn off the device completely, then power it back on. After awhile, the firmware update process will start automatically. During the update, the screen will display the inscription “Upgrading...”. The update process will be completed when the inscription “Upgrading...” goes out.

6. Turn off the device and disconnect it from your PC.

You can also enjoy automatic update function in AGM Connect App (see section 2.3 for details).

1. Start the AGM Connect App and tap the Settings icon in the left top corner.

2. Tap your device in the device list. The information about your device will be shown.

3. Tap **Checking for Upgrade** to detect and download the latest FW version.

3.2 TROUBLESHOOTING

Table 3-1 lists the most common malfunctions that may occur with your equipment. This table does not list all the malfunctions that may occur with your device. If the equipment malfunction is not corrected by the suggested actions, or a problem occurs that is not listed in this table, please contact AGM Global Vision’s Customer Support center or your retailer.

TABLE 3-1. TROUBLESHOOTING

| MALFUNCTION | CORRECTIVE ACTION |
|--|--|
| The scope fails to activate. | <ol style="list-style-type: none"> 1. Battery is missing or improperly installed. Insert battery or install correctly. 2. Battery is dead. Replace the batteries. 3. Battery, surfaces or contacts are dirty or corroded. Clean the contact. |
| The scope shut off sometimes after shot. | <ol style="list-style-type: none"> 1. Low battery level. Check the remaining capacity of the batteries, which may be low on power to maintain performance. Replace the battery. |
| The image is not clear. | Perform the sight adjustment referring to section 2.1. |
| Wi-Fi is not found. | Examine whether the Wi-Fi function is turned on. If not, turn on the Wi-Fi hotspot in the menu. |
| Capturing or recording fails. | <ol style="list-style-type: none"> 1. The device is connected to your PC and has disabled the capturing and recording. Disconnect the device. 2. The storage space is full. Delete old files. 3. The device is in a low-battery condition. Replace the battery. |
| The PC cannot identify the scope. | <ol style="list-style-type: none"> 1. The device is connected to your PC with standard USB cable. If you use other USB cables, make sure the cable length is no longer than 1 m. 2. The Wi-Fi function is turned on. If so, turn off the Wi-Fi hotspot in the menu. |

4 WARRANTY INFORMATION

4.1 WARRANTY INFORMATION AND REGISTRATION

The below description of AGM Global Vision warranty terms and conditions refer specifically to AGM branded products purchased within the United States. Customers purchasing AGM products outside the United States can obtain specific information about their product's warranty term on the www.agmglobalvision.eu website.

4.1.1 WARRANTY INFORMATION

This product is guaranteed to be free from manufacturing defects in material and workmanship under normal use for a period of five (5) years from the date of purchase. In the event that a defect covered by the warranty below occurs during the applicable period stated above, AGM Global Vision, at its discretion, will either repair or replace the product; such action on the part of AGM Global Vision shall be the full extent of AGM Global Vision's liability, and the Customer's sole and exclusive reparation. This warranty does not cover a product if it has been (a) used in ways other than its normal and customary manner; (b) subjected to misuse; (c) subjected to alterations, modifications or repairs by the Customer or by any party other than AGM Global Vision without prior written consent of AGM Global Vision; (d) is the result of a special order or categorized as "close-out" merchandise or merchandise sold "as-is" by either AGM Global Vision or the AGM Global Vision dealer; or (e) merchandise that has been discontinued by the manufacturer and either parts or replacement units are not available due to reasons beyond the control of AGM Global Vision. AGM Global Vision shall not be responsible for any defects or damage that in AGM Global Vision's view are a result from the mishandling, abuse, misuse, improper storage or improper operation of the device, including use in conjunction with equipment that is electrically or mechanically incompatible with, or of inferior quality to, the product, as well as failure to maintain the environmental conditions specified by the manufacturer. This warranty is extended only to the original purchaser. Any breach of this warranty shall be enforced unless the customer notifies AGM Global Vision at the address noted below within the applicable warranty period.

The customer understands and agrees that except for the foregoing warranty, no other warranties written or oral, statutory, expressed or implied, including any implied warranty of merchantability or fitness for a particular purpose, shall apply to the product. All such implied warranties are hereby and expressly disclaimed.

4.1.2 LIMITATION OF LIABILITY

AGM Global Vision will not be liable for any claims, actions, suits, proceedings, costs, expenses, damages, or liabilities arising out of the use of this product. Operation and use of the product are the sole responsibility of the Customer. AGM Global Vision's sole undertaking is limited to providing the products and services outlined herein in accordance with the terms and conditions of

this Agreement. The provision of products sold and services performed by AGM Global Vision to the Customer shall not be interpreted, construed, or regarded, either expressly or implied, as being for the benefit of or creating any obligation toward any third party of legal entity outside AGM Global Vision and the Customer; AGM Global Vision's obligations under this Agreement extend solely to the Customer. AGM Global Vision's liability hereunder for damages, regardless of the form or action, shall not exceed the fees or other charges paid to AGM Global Vision by the customer or customer's dealer. AGM Global Vision shall not, in any event, be liable for special, indirect, incidental, or consequential damages, including, but not limited to, lost income, lost revenue, or lost profit, whether such damages were foreseeable or not at the time of purchase, and whether or not such damages arise out of a breach of warranty, a breach of agreement, negligence, strict liability, or any other theory of liability.

4.1.3 PRODUCT REGISTRATION

In order to validate the warranty on your product, the customer must complete and submit AGM Global Vision PRODUCT REGISTRATION FORM on our website (www.agmglobalvision.com/customer-support).

4.1.4 OBTAINING WARRANTY SERVICE

To obtain warranty service on your unit, the End-user (Customer) must notify the AGM Global Vision service department via e-mail. Send any requests to support@agmglobalvision.com to receive a Return Merchandise Authorization number (RMA). When returning any device, please take the product to your retailer, or send the product, postage paid and with a copy of your sales receipt, to AGM Global Vision's service center at the address listed above. All merchandise must be fully insured with the correct postage; AGM Global Vision will not be responsible for improper postage or merchandise that becomes lost or damaged during shipment. When sending product back, please clearly write the RMA# on the outside of the shipping box. Please include a letter that indicates your RMA#, the Customer's Name, a Return Address, reason for the return, contact information (valid telephone numbers and/or an e-mail address), and proof of purchase that will help us to establish the valid start date of the warranty. Product merchandise returns that do not have an RMA# listed may be refused, or a significant delay in processing may occur. Estimated Warranty service time is 10-20 business days. The End-user/Customer is responsible for postage to AGM Global Vision for warranty service. AGM Global Vision will cover return postage/shipping after warranty repair to the End-user/Customer only if the product is covered by the aforementioned warranty. AGM Global Vision will return the product after warranty service by domestic UPS Ground service and/or domestic mail. Should any other requested, required, or international shipping methods be necessary, the postage/shipping fee will be the responsibility of the End-user/Customer.

For service, repair or replacement, please contact:

AGM Global Vision, LLC

173 West Main Street

PO Box 962

Springerville, AZ 85938

Tel. 928.333.4300

support@agmglobalvision.com

www.agmglobalvision.com

5 SPECIFICATIONS

5.1 RATTLERV² 256 SPECIFICATIONS

| | RATTLER V ² 19-256 | RATTLER V ² 25-256 |
|-----------------------------|---------------------------------------|---------------------------------------|
| Detector | 12μm VOx Uncooled Focal Plane Array | 12μm VOx Uncooled Focal Plane Array |
| Resolution | 256 × 192 | 256 × 192 |
| NETD | Less than 35 mK (25°C, F# = 1.0) | Less than 35 mK (25°C, F# = 1.0) |
| Refresh Rate | 50 Hz | 50 Hz |
| Lens System | 19 mm; F/1.0 | 25 mm; F/1.0 |
| Magnification | 2.5× - 20× | 3.5× - 28× |
| Field of View | 9.3° × 6.9° | 7.0° × 5.3° |
| Diopter Adjustment | -5 to +5 diopters | -5 to +5 diopters |
| Focus Range | 0.5 m to infinity | 0.5 m to infinity |
| Exit Pupil | 6 mm | 6 mm |
| Eye Relief | 45 mm | 45 mm |
| Digital Zoom | 1×, 2×, 4×, 8× | 1×, 2×, 4×, 8× |
| Detection Range (6' object) | 950 m/yd | 1250 m/yd |
| Display | 0.39-inch, OLED, 1024×768 | 0.39-inch, OLED, 1024×768 |
| Palettes | Black hot, White hot, Red hot, Fusion | Black hot, White hot, Red hot, Fusion |
| Flat Field Correction | Auto, Semi-Auto, Manual | Auto, Semi-Auto, Manual |
| Scene Mode | Cold, Warm | Cold, Warm |
| Boresight Adjustment | Digital Controlled | Digital Controlled |
| Video/Audio Recording | Yes | Yes |
| Image Capture | Yes | Yes |
| Standby Mode | Yes | Yes |
| Storage | Built-in EMMC (16 GB) | Built-in EMMC (16 GB) |
| PIP | Yes | Yes |
| Defective Pixel Correction | Yes | Yes |
| WiFi Hotspot | Yes | Yes |
| Hot Track | Yes | Yes |
| Reticle | 10 types, 4 colors, on/off | 10 types, 4 colors, on/off |

| | RATTLER V ² 19-256 | RATTLER V ² 25-256 |
|--------------------------------|---|---|
| Distance Measurement | Yes (Stadiametric) | Yes (Stadiametric) |
| Shot Activated Recording (SAR) | Yes | Yes |
| Battery Type | Replaceable and Rechargeable Li-Ion Battery | Replaceable and Rechargeable Li-Ion Battery |
| Battery Life (Operating) | Up to 11.5 hours on a single charge (25°C, hotspot off) | Up to 11.5 hours on a single charge (25°C, hotspot off) |
| External Power Supply | 5 VDC, 2 A, USB Type-C | 5 VDC, 2 A, USB Type-C |
| Operating Temperature Range | -30°C to +55°C (-22°F to 131°F) | -30°C to +55°C (-22°F to 131°F) |
| Protection Level | IP67 | IP67 |
| Max. Recoil | 1000 g/0.4 ms | 1000 g/0.4 ms |
| Weight (w/o mount and battery) | 0.48 kg (1.06 lb) | 0.49 kg (1.08 lb) |
| Dimensions (w/o mount) | 219 × 68 × 67 mm (8.5 × 2.7 × 2.6 in) | 219 × 68 × 67 mm (8.5 × 2.7 × 2.6 in) |

5.2 RATTLER V² 384 SPECIFICATIONS

| | RATTLER V ² 25-384 | RATTLER V ² 35-384 |
|-----------------------------|---------------------------------------|---------------------------------------|
| Detector | 12µm VOx Uncooled Focal Plane Array | 12µm VOx Uncooled Focal Plane Array |
| Resolution | 384 × 288 | 384 × 288 |
| NETD | Less than 20 mK (25°C, F# = 1.0) | Less than 20 mK (25°C, F# = 1.0) |
| Refresh Rate | 50 Hz | 50 Hz |
| Lens System | 25 mm; F/1.0 | 35 mm; F/1.0 |
| Magnification | 2× - 16× | 3× - 24× |
| Field of View | 10.5° × 7.9° | 7.5° × 5.6° |
| Diopter Adjustment | -5 to +5 diopters | -5 to +5 diopters |
| Focus Range | 0.5 m to infinity | 2 m to infinity |
| Exit Pupil | 6 mm | 6 mm |
| Eye Relief | 45 mm | 45 mm |
| Digital Zoom | 1×, 2×, 4×, 8× | 1×, 2×, 4×, 8× |
| Detection Range (6' object) | 1200 m/yd | 1800 m/yd |
| Display | 0.39-inch, OLED, 1024×768 | 0.39-inch, OLED, 1024×768 |
| Palettes | Black hot, White hot, Red hot, Fusion | Black hot, White hot, Red hot, Fusion |
| Flat Field Correction | Auto, Semi-Auto, Manual | Auto, Semi-Auto, Manual |

| | RATTLER V ² 25-384 | RATTLER V ² 35-384 |
|--------------------------------|---|---|
| Scene Mode | Cold, Warm | Cold, Warm |
| Boresight Adjustment | Digital Controlled | Digital Controlled |
| Video/Audio Recording | Yes | Yes |
| Image Capture | Yes | Yes |
| Standby Mode | Yes | Yes |
| Storage | Built-in EMMC (16 GB) | Built-in EMMC (16 GB) |
| PIP | Yes | Yes |
| Defective Pixel Correction | Yes | Yes |
| WiFi Hotspot | Yes | Yes |
| Hot Track | Yes | Yes |
| Reticle | 10 types, 4 colors, on/off | 10 types, 4 colors, on/off |
| Distance Measurement | Yes (Stadiametric) | Yes (Stadiametric) |
| Shot Activated Recording (SAR) | Yes | Yes |
| Battery Type | Replaceable and Re-chargeable Li-Ion Battery | Replaceable and Re-chargeable Li-Ion Battery |
| Battery Life (Operating) | Up to 11 hours on a single charge (25°C, hotspot off) | Up to 11 hours on a single charge (25°C, hotspot off) |
| External Power Supply | 5 VDC, 2 A, USB Type-C | 5 VDC, 2 A, USB Type-C |
| Operating Temperature Range | -30°C to +55°C (-22°F to 131°F) | -30°C to +55°C (-22°F to 131°F) |
| Protection Level | IP67 | IP67 |
| Max. Recoil | 1000 g/0.4 ms | 1000 g/0.4 ms |
| Weight (w/o mount and battery) | 0.49 kg (1.08 lb) | 0.51 kg (1.13 lb) |
| Dimensions (w/o mount) | 219 × 68 × 67 mm (8.5 × 2.7 × 2.6 in) | 221 × 68 × 67 mm (8.7 × 2.7 × 2.6 in) |

5.3 RATTLER V² 640 SPECIFICATIONS

| | RATTLER V ² 35-640 | RATTLER V ² 50-640 |
|---------------|-------------------------------------|-------------------------------------|
| Detector | 12µm VOx Uncooled Focal Plane Array | 12µm VOx Uncooled Focal Plane Array |
| Resolution | 640 × 512 | 640 × 512 |
| NETD | Less than 20 mK (25°C, F# = 1.0) | Less than 20 mK (25°C, F# = 1.0) |
| Refresh Rate | 50 Hz | 50 Hz |
| Lens System | 35 mm; F/1.0 | 50 mm; F/1.0 |
| Magnification | 2× - 16× | 2.5× - 20× |
| Field of View | 12.5° × 10.0° | 8.8° × 7.0° |



| | RATTLER V ² 35-640 | RATTLER V ² 50-640 |
|--------------------------------|--|--|
| Diopter Adjustment | -5 to +5 diopters | -5 to +5 diopters |
| Focus Range | 2 m to infinity | 10 m to infinity |
| Exit Pupil | 6 mm | 6 mm |
| Eye Relief | 45 mm | 45 mm |
| Digital Zoom | 1x, 2x, 4x, 8x | 1x, 2x, 4x, 8x |
| Detection Range (6' object) | 1800 m/yd | 2600 m/yd |
| Display | 0.39-inch, OLED, 1024x768 | 0.39-inch, OLED, 1024x768 |
| Palettes | Black hot, White hot, Red hot, Fusion | Black hot, White hot, Red hot, Fusion |
| Flat Field Correction | Auto, Semi-Auto, Manual | Auto, Semi-Auto, Manual |
| Scene Mode | Cold, Warm | Cold, Warm |
| Boresight Adjustment | Digital Controlled | Digital Controlled |
| Video/Audio Recording | Yes | Yes |
| Image Capture | Yes | Yes |
| Standby Mode | Yes | Yes |
| Storage | Built-in EMMC (16 GB) | Built-in EMMC (16 GB) |
| PIP | Yes | Yes |
| Defective Pixel Correction | Yes | Yes |
| WiFi Hotspot | Yes | Yes |
| Hot Track | Yes | Yes |
| Reticle | 10 types, 4 colors, on/off | 10 types, 4 colors, on/off |
| Distance Measurement | Yes (Stadiametric) | Yes (Stadiametric) |
| Shot Activated Recording (SAR) | Yes | Yes |
| Battery Type | Replaceable and Rechargeable Li-Ion Battery | Replaceable and Rechargeable Li-Ion Battery |
| Battery Life (Operating) | Up to 9 hours on a single charge (25°C, hotspot off) | Up to 9 hours on a single charge (25°C, hotspot off) |
| External Power Supply | 5 VDC, 2 A, USB Type-C | 5 VDC, 2 A, USB Type-C |
| Operating Temperature Range | -30°C to +55°C (-22°F to 131°F) | -30°C to +55°C (-22°F to 131°F) |
| Protection Level | IP67 | IP67 |
| Max. Recoil | 1000 g/0.4 ms | 1000 g/0.4 ms |
| Weight (w/o mount and battery) | 0.51 kg (1.13 lb) | 0.53 kg (1.18 lb) |
| Dimensions (w/o mount) | 221 × 68 × 67 mm (8.7 × 2.7 × 2.6 in) | 230 × 73 × 68 mm (9.0 × 2.9 × 2.7 in) |

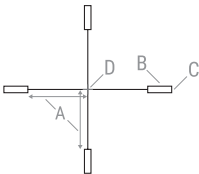
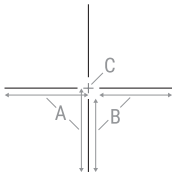
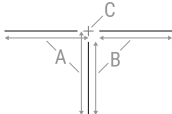

All data subject to change without notice.

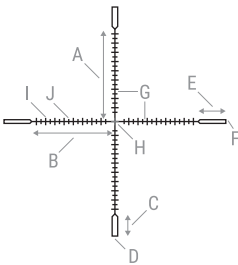
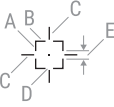
5.4 RATTLE RV² RETICLE PARAMETERS

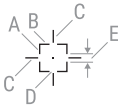
| IMAGE | ITEM | MOA | CM @ 100 M | IN @ 100 YD | ITEM | MOA | CM @ 100 M | IN @ 100 YD | |
|---|---|-------------------------------------|------------|-------------------------------------|-------------------------------------|-------------------------------------|------------|-------------|-------|
|  | Rattler V² 19-256 | | | | Rattler V² 25-256 | | | | |
| | A | 115.4 | 335.7 | 120.8 | A | 87.8 | 255.4 | 91.9 | |
| | B | 23.3 | 67.8 | 24.4 | B | 17.7 | 51.5 | 18.5 | |
| | C | 7.0 | 20.4 | 7.3 | C | 5.4 | 15.7 | 5.7 | |
| | D | 7.6 | 22.1 | 8.0 | D | 5.8 | 16.9 | 6.1 | |
| | Rattler V² 25-384 | | | | Rattler V² 35-384 | | | | |
| | A | 131.4 | 382.2 | 137.6 | A | 94.0 | 273.4 | 98.4 | |
| | B | 26.5 | 77.1 | 27.7 | B | 19.0 | 55.3 | 19.9 | |
| | C | 8.0 | 23.3 | 8.4 | C | 5.7 | 16.6 | 6.0 | |
| | D | 8.6 | 25.0 | 9.0 | D | 6.2 | 18.0 | 6.5 | |
| | Rattler V² 35-640 | | | | Rattler V² 50-640 | | | | |
| | A | 166.9 | 485.5 | 174.7 | A | 117.0 | 340.4 | 122.5 | |
| | B | 31.5 | 91.6 | 33.0 | B | 22.1 | 64.3 | 23.1 | |
| | C | 10.2 | 29.7 | 10.7 | C | 7.1 | 20.7 | 7.4 | |
| | D | 11.0 | 32.0 | 11.5 | D | 7.7 | 22.4 | 8.1 | |
| |  | Rattler V² 19-256 | | | | Rattler V² 25-256 | | | |
| A | | 138.1 | 401.7 | 144.6 | A | 105.1 | 305.7 | 110.0 | |
| B | | 128.9 | 375.0 | 135.0 | B | 98.1 | 285.4 | 102.7 | |
| C | | 7.6 | 22.1 | 8.0 | C | 5.8 | 16.9 | 6.1 | |
| Rattler V² 25-384 | | | | Rattler V² 35-384 | | | | | |
| A | | 157.3 | 457.6 | 164.7 | A | 112.5 | 327.3 | 117.8 | |
| B | | 146.8 | 427.0 | 153.7 | B | 105.0 | 305.4 | 109.9 | |
| C | | 8.6 | 25.0 | 9.0 | C | 6.2 | 18.0 | 6.5 | |
| Rattler V² 35-640 | | | | Rattler V² 50-640 | | | | | |
| A | | 199.8 | 581.2 | 209.2 | A | 140.1 | 407.6 | 146.7 | |
| B | | 186.5 | 542.5 | 195.3 | B | 130.7 | 380.2 | 136.8 | |
| C | | 11.0 | 32.0 | 11.5 | C | 7.7 | 22.4 | 8.1 | |
|  | | Rattler V² 19-256 | | | | Rattler V² 25-256 | | | |
| | | A | 138.1 | 401.7 | 144.6 | A | 105.1 | 305.7 | 110.0 |
| | | B | 128.9 | 375.0 | 135.0 | B | 98.1 | 285.4 | 102.7 |
| | | C | 7.6 | 22.1 | 8.0 | C | 5.8 | 16.9 | 6.1 |
| | Rattler V² 25-384 | | | | Rattler V² 35-384 | | | | |
| | A | 157.3 | 457.6 | 164.7 | A | 112.5 | 327.3 | 117.8 | |
| | B | 146.8 | 427.0 | 153.7 | B | 105.0 | 305.4 | 109.9 | |
| | C | 8.6 | 25.0 | 9.0 | C | 6.2 | 18.0 | 6.5 | |
| | Rattler V² 35-640 | | | | Rattler V² 50-640 | | | | |
| | A | 199.8 | 581.2 | 209.2 | A | 140.1 | 407.6 | 146.7 | |
| | B | 186.5 | 542.5 | 195.3 | B | 130.7 | 380.2 | 136.8 | |
| | C | 11.0 | 32.0 | 11.5 | C | 7.7 | 22.4 | 8.1 | |

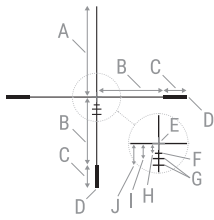
| IMAGE | ITEM | MOA | CM @ 100M | IN @ 100YD | ITEM | MOA | CM @ 100M | IN @ 100YD |
|---|-------------------------------------|-------|-----------|------------|-------------------------------------|-------|-----------|------------|
|  | Rattler V² 19-256 | | | | Rattler V² 25-256 | | | |
| | A | 107.8 | 313.6 | 112.9 | A | 82.0 | 238.5 | 85.9 |
| | B | 98.0 | 285.1 | 102.6 | B | 74.6 | 217.0 | 78.1 |
| | C | 26.0 | 75.6 | 27.2 | C | 19.8 | 57.6 | 20.7 |
| | D | 4.9 | 14.3 | 5.1 | D | 3.7 | 10.8 | 3.9 |
| | E | 31.9 | 92.8 | 33.4 | E | 24.3 | 70.7 | 25.4 |
| | F | 2.7 | 7.9 | 2.8 | F | 2.1 | 6.1 | 2.2 |
| | G | 6.5 | 18.9 | 6.8 | G | 6.6 | 19.2 | 6.9 |
| | H | 7.6 | 22.1 | 8.0 | H | 5.8 | 16.9 | 6.1 |
| | I | 6.5 | 18.9 | 6.8 | I | 4.9 | 14.3 | 5.1 |
| | J | 4.3 | 12.5 | 4.5 | J | 3.3 | 9.6 | 3.5 |
| | Rattler V² 25-384 | | | | Rattler V² 35-384 | | | |
| | A | 122.8 | 357.2 | 128.6 | A | 87.8 | 255.4 | 91.9 |
| | B | 111.7 | 324.9 | 116.9 | B | 79.9 | 232.4 | 83.7 |
| | C | 29.6 | 86.1 | 31.0 | C | 21.2 | 61.7 | 22.2 |
| | D | 5.5 | 16.0 | 5.8 | D | 4.0 | 11.6 | 4.2 |
| | E | 36.3 | 105.6 | 38.0 | E | 26.0 | 75.6 | 27.2 |
| | F | 3.1 | 9.0 | 3.2 | F | 2.2 | 6.4 | 2.3 |
| | G | 6.8 | 19.8 | 7.1 | G | 6.6 | 19.2 | 6.9 |
| | H | 8.6 | 25.0 | 9.0 | H | 6.2 | 18.0 | 6.5 |
| | I | 7.4 | 21.5 | 7.7 | I | 5.3 | 15.4 | 5.5 |
| | J | 4.9 | 14.3 | 5.1 | J | 3.5 | 10.2 | 3.7 |
| | Rattler V² 35-640 | | | | Rattler V² 50-640 | | | |
| | A | 156.0 | 453.8 | 163.3 | A | 109.3 | 318.0 | 114.4 |
| | B | 132.8 | 386.3 | 139.0 | B | 93.1 | 270.8 | 97.5 |
| | C | 37.6 | 109.4 | 39.4 | C | 26.3 | 76.5 | 27.5 |
| | D | 6.6 | 19.2 | 6.9 | D | 4.6 | 13.4 | 4.8 |
| | E | 43.4 | 126.3 | 45.4 | E | 30.4 | 88.4 | 31.8 |
| | F | 3.9 | 11.3 | 4.1 | F | 2.7 | 7.9 | 2.8 |
| | G | 7.0 | 20.4 | 7.3 | G | 7.1 | 20.7 | 7.4 |
| | H | 11.0 | 32.0 | 11.5 | H | 7.7 | 22.4 | 8.1 |
| | I | 9.4 | 27.3 | 9.8 | I | 6.6 | 19.2 | 6.9 |
| J | 6.3 | 18.3 | 6.6 | J | 4.4 | 12.8 | 4.6 | |
| RETICLE 5 | Rattler V² 19-256 | | | | Rattler V² 25-256 | | | |
|  | A | 3.8 | 11.1 | 4.0 | A | 2.9 | 8.4 | 3.0 |
| | B | 3.8 | 11.1 | 4.0 | B | 2.9 | 8.4 | 3.0 |
| | C | 4.3 | 12.5 | 4.5 | C | 3.3 | 9.6 | 3.5 |
| | D | 0.1 | 0.3 | 0.1 | D | 0.8 | 2.3 | 0.8 |
| | E | 1.6 | 4.7 | 1.7 | E | 1.2 | 3.5 | 1.3 |
| | Rattler V² 25-384 | | | | Rattler V² 35-384 | | | |
| | A | 4.3 | 12.5 | 4.5 | A | 3.1 | 9.0 | 3.2 |
| | B | 4.3 | 12.5 | 4.5 | B | 3.1 | 9.0 | 3.2 |
| | C | 4.9 | 14.3 | 5.1 | C | 3.5 | 10.2 | 3.7 |
| | D | 1.2 | 3.5 | 1.3 | D | 0.9 | 2.6 | 0.9 |
| | E | 1.8 | 5.2 | 1.9 | E | 1.3 | 3.8 | 1.4 |

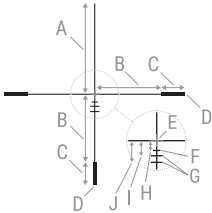
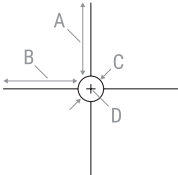
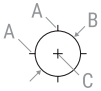
| IMAGE | ITEM | MOA | CM @ 100M | IN @ 100YD | ITEM | MOA | CM @ 100M | IN @ 100YD |
|--|-------------------------------------|-------|--------------|---------------|-------------------------------------|-------|--------------|---------------|
|  | Rattler V² 35-640 | | | | Rattler V² 50-640 | | | |
| | A | 5.1 | 14.8 | 5.3 | A | 3.6 | 10.5 | 3.8 |
| | B | 5.5 | 16.0 | 5.8 | B | 3.8 | 11.1 | 4.0 |
| | C | 6.3 | 18.3 | 6.6 | C | 4.4 | 12.8 | 4.6 |
| | D | 1.5 | 4.4 | 1.6 | D | 1.0 | 2.9 | 1.0 |
| | E | 2.3 | 6.7 | 2.4 | E | 1.6 | 4.7 | 1.7 |
|  | Rattler V² 19-256 | | | | Rattler V² 25-256 | | | |
| | A | 6.5 | 18.9 | 6.8 | A | 4.9 | 14.3 | 5.1 |
| | B | 6.5 | 18.9 | 6.8 | B | 4.9 | 14.3 | 5.1 |
| | C | 1.6 | 4.7 | 1.7 | C | 1.2 | 3.5 | 1.3 |
| | Rattler V² 25-384 | | | | Rattler V² 35-384 | | | |
| | A | 7.4 | 21.5 | 7.7 | A | 5.3 | 15.4 | 5.5 |
| | B | 7.4 | 21.5 | 7.7 | B | 5.3 | 15.4 | 5.5 |
| | C | 1.8 | 5.2 | 1.9 | C | 1.3 | 3.8 | 1.4 |
| | Rattler V² 35-640 | | | | Rattler V² 50-640 | | | |
| | A | 9.4 | 27.3 | 9.8 | A | 6.6 | 19.2 | 6.9 |
| | B | 8.8 | 25.6 | 9.2 | B | 6.2 | 18.0 | 6.5 |
| | C | 2.2 | 6.4 | 2.3 | C | 1.5 | 4.4 | 1.6 |
|  | Rattler V² 19-256 | | | | Rattler V² 25-256 | | | |
| | A | 138.6 | 403.2 | 145.1 | A | 105.5 | 306.9 | 110.5 |
| | B | 112.1 | 326.1 | 117.4 | B | 85.3 | 248.1 | 89.3 |
| | C | 26.5 | 77.1 | 27.7 | C | 20.2 | 58.8 | 21.1 |
| | D | 3.8 | 11.1 | 4.0 | D | 2.9 | 8.4 | 3.0 |
| | E | 7.6 | 22.1 | 8.0 | E | 5.8 | 16.9 | 6.1 |
| | F | 4.3 | 12.5 | 4.5 | F | 3.3 | 9.6 | 3.5 |
| | G | 6.5 | 18.9 | 6.8 | G | 4.9 | 14.3 | 5.1 |
| | H | 3.2 | 9.3 | 3.4 | H | 3.3 | 9.6 | 3.5 |
| | I | 5.4 | 15.7 | 5.7 | I | 5.4 | 15.7 | 5.7 |
| | J | 8.1 | 23.6 | 8.5 | J | 7.2 | 20.9 | 7.5 |
| | Rattler V² 25-384 | | | | Rattler V² 35-384 | | | |
| | A | 158.0 | 459.6 | 165.4 | A | 113.0 | 328.7 | 118.3 |
| | B | 127.7 | 371.5 | 133.7 | B | 91.3 | 265.6 | 95.6 |
| | C | 30.2 | 87.9 | 31.6 | C | 21.6 | 62.8 | 22.6 |
| | D | 4.3 | 12.5 | 4.5 | D | 3.1 | 9.0 | 3.2 |
| | E | 8.6 | 25.0 | 9.0 | E | 6.2 | 18.0 | 6.5 |
| | F | 4.9 | 14.3 | 5.1 | F | 3.5 | 10.2 | 3.7 |
| | G | 7.4 | 21.5 | 7.7 | G | 5.3 | 15.4 | 5.5 |
| | H | 3.7 | 10.8 | 3.9 | H | 3.5 | 10.2 | 3.7 |
| I | 5.5 | 16.0 | 5.8 | I | 5.3 | 15.4 | 5.5 | |
| J | 8.0 | 23.3 | 8.4 | J | 7.9 | 23.0 | 8.3 | |

| IMAGE | ITEM | MOA | CM @ 100 M | IN @ 100 YD | ITEM | MOA | CM @ 100 M | IN @ 100 YD |
|---|---|-------------------------------------|------------|-------------------------------------|-------------------------------------|-------------------------------------|------------|-------------|
|  | Rattler V² 35-640 | | | | Rattler V² 50-640 | | | |
| | A | 200.6 | 583.5 | 210.0 | A | 140.6 | 409.0 | 147.2 |
| | B | 151.9 | 441.9 | 159.0 | B | 106.5 | 309.8 | 111.5 |
| | C | 35.9 | 104.4 | 37.6 | C | 25.2 | 73.3 | 26.4 |
| | D | 5.5 | 16.0 | 5.8 | D | 3.8 | 11.1 | 4.0 |
| | E | 11.0 | 32.0 | 11.5 | E | 7.7 | 22.4 | 8.1 |
| | F | 5.9 | 17.2 | 6.2 | F | 4.1 | 11.9 | 4.3 |
| | G | 8.8 | 25.6 | 9.2 | G | 6.2 | 18.0 | 6.5 |
| | H | 3.1 | 9.0 | 3.2 | H | 3.3 | 9.6 | 3.5 |
| | I | 5.5 | 16.0 | 5.8 | I | 5.5 | 16.0 | 5.8 |
| | J | 7.8 | 22.7 | 8.2 | J | 8.2 | 23.9 | 8.6 |
| |  | Rattler V² 19-256 | | | | Rattler V² 25-256 | | |
| A | | 122.4 | 356.1 | 128.2 | A | 93.1 | 270.8 | 97.5 |
| B | | 122.4 | 356.1 | 128.2 | B | 93.1 | 270.8 | 97.5 |
| C | | 31.9 | 92.8 | 33.4 | C | 24.3 | 70.7 | 25.4 |
| D | | 3.8 | 11.1 | 4.0 | D | 2.9 | 8.4 | 3.0 |
| Rattler V² 25-384 | | | | Rattler V² 35-384 | | | | |
| A | | 139.4 | 405.5 | 146.0 | A | 99.7 | 290.0 | 104.4 |
| B | | 139.4 | 405.5 | 146.0 | B | 99.7 | 290.0 | 104.4 |
| C | | 36.4 | 105.9 | 38.1 | C | 26.0 | 75.6 | 27.2 |
| D | | 4.3 | 12.5 | 4.5 | D | 3.1 | 9.0 | 3.2 |
| Rattler V² 35-640 | | | | Rattler V² 50-640 | | | | |
| A | | 177.1 | 515.2 | 185.4 | A | 124.1 | 361.0 | 129.9 |
| B | 177.1 | 515.2 | 185.4 | B | 124.1 | 361.0 | 129.9 | |
| C | 43.3 | 126.0 | 45.3 | C | 30.4 | 88.4 | 31.8 | |
| D | 5.1 | 14.8 | 5.3 | D | 3.6 | 10.5 | 3.8 | |
|  | Rattler V² 19-256 | | | | Rattler V² 25-256 | | | |
| | A | 3.2 | 9.3 | 3.4 | A | 2.5 | 7.3 | 2.6 |
| | B | 32.5 | 94.5 | 34.0 | B | 24.7 | 71.9 | 25.9 |
| | C | 3.8 | 11.1 | 4.0 | C | 2.9 | 8.4 | 3.0 |
| | Rattler V² 25-384 | | | | Rattler V² 35-384 | | | |
| | A | 3.7 | 10.8 | 3.9 | A | 2.6 | 7.6 | 2.7 |
| | B | 37.0 | 107.6 | 38.7 | B | 26.5 | 77.1 | 27.7 |
| | C | 4.3 | 12.5 | 4.5 | C | 3.1 | 9.0 | 3.2 |
| | Rattler V² 35-640 | | | | Rattler V² 50-640 | | | |
| | A | 4.7 | 13.7 | 4.9 | A | 3.3 | 9.6 | 3.5 |
| | B | 44.0 | 128.0 | 46.1 | B | 30.9 | 89.9 | 32.4 |
| | C | 5.5 | 16.0 | 5.8 | C | 3.8 | 11.1 | 4.0 |
|  | Rattler V² 19-256 | | | | Rattler V² 25-256 | | | |
| | A | 6.0 | 17.5 | 6.3 | A | 4.5 | 13.1 | 4.7 |
| | Rattler V² 25-384 | | | | Rattler V² 35-384 | | | |
| | A | 6.8 | 19.8 | 7.1 | A | 4.8 | 14.0 | 5.0 |
| | Rattler V² 35-640 | | | | Rattler V² 50-640 | | | |
| A | 8.1 | 23.6 | 8.5 | A | 5.7 | 16.6 | 6.0 | |

All data subject to change without notice.



AGM Global Vision, LLC

MAIN OFFICE

173 West Main Street

PO Box 962

Springerville, AZ 85938

USA

Tel. +1.928.333.4300

info@agmglobalvision.com

www.agmglobalvision.com

EUROPEAN OFFICE

#6 Andrey Lyapchev Blvd

Sofia, P.C. 1756

Bulgaria

Tel. +35.988.560.0326

info@agmglobalvision.eu

www.agmglobalvision.eu

DOWNLOAD AGM CONNECT APP:



Google Play Store



Apple App Store

AGMglobalvision.com