

SECUTOR LRF-C

THERMAL IMAGING CLIP-ON
WITH LASER RANGEFINDER

© 2024 AGM Global Vision, LLC. All rights reserved.

This documentation is subject to change without notice.

No parts of this manual, in whole or in part, may be copied, photocopied, translated, or transmitted by any electronic medium or in machine-readable form without the prior written permission of AGM Global Vision, LLC.

Approved for public release, distribution unlimited.

If you have questions that are not covered in this manual, or need service, contact AGM Global Vision customer support for additional information prior to returning a product.

AGM Global Vision, LLC

173 West Main Street

PO Box 962

Springerville, AZ 85938

Tel. 928.333.4300

support@agmglobalvision.com

www.agmglobalvision.com

EXPORT INFORMATION

Buyer acknowledges that all products supplied by AGM Global Vision, LLC are subject to U.S. export control laws, including, but not limited to, the Export Administration Regulations, the International Traffic in Arms Regulations, the International Economic Emergency Powers Act, and various U.S. embargoes and sanctions. AGM Global Vision products may not be exported, re-exported, or transferred contrary to U.S. export control laws. In particular, AGM Global Vision products may not be exported, re-exported, or transferred to prohibited countries, individuals, organizations, or entities, including but not limited to those individuals and entities listed on the List of Specially Designated Nationals and Blocked Persons administered or maintained by the U.S. Office of Foreign Assets Control ("OFAC"), the various lists maintained by the Bureau of Industry and Security of the Department of Commerce, and the U.S. State Department and Buyer represents and warrants that neither Buyer nor any of its officers, directors, or employees are on such lists. Distribution or resale by Buyer to such countries, individuals, organizations, or entities is expressly prohibited. Buyer has and will maintain a positive process to ensure compliance with this Section.

FCC INFORMATION

Please take attention that changes or modification not expressly approved by the party responsible for compliance could void the user's authority to operate the equipment.



This equipment complies with FCC/IC RSS-102 radiation exposure limits set forth for an uncontrolled environment.

FCC compliance: This product has been tested and found to comply with the limits for a Class B digital device, pursuant to Part 15 of the FCC Rules. These limits are designed to provide reasonable protection against harmful interference in a residential installation. This product generates, uses, and can radiate radio frequency energy and, if not installed and used in accordance with the instructions, may cause harmful interference to radio communications. However, there is no guarantee that interference will not occur in a particular installation. If this product does cause harmful interference to radio or television reception, which can be determined by turning the equipment off and on, the user is encouraged to try to correct the interference by one or more of the following measures:

- Reorient or relocate the receiving antenna.
- Increase the separation between the equipment and receiver.
- Connect the equipment into an outlet on a circuit different from that to which the receiver is connected.
- Consult the dealer or an experienced radio/TV technician for help.

FCC Conditions

This device complies with part 15 of the FCC Rules. Operation is subject to the following two conditions:

1. This device may not cause harmful interference.
2. This device must accept any interference received, including interference that may cause undesired operation.

EU CONFORMITY STATEMENT



This product and - if applicable - the supplied accessories too are marked with "CE" and comply therefore with the applicable harmonized European standards listed under the EMC Directive 2014/30/EU, the RoHS Directive 2011/65/EU



2012/19/EU (WEEE directive): Products marked with this symbol cannot be disposed of as unsorted municipal waste in the European Union. For proper recycling, return this product to your local supplier upon the purchase of equivalent new equipment, or dispose of it at designated collection points. For more information see: www.recyclethis.info



2006/66/EC (battery directive): This product contains a battery that cannot be disposed of as unsorted municipal waste in the European Union. See the product documentation for specific battery information. The battery is marked with this symbol, which may include lettering to indicate cadmium (Cd), lead (Pb), or mercury (Hg). For proper recycling, return the battery to your supplier or to a designated collection point. For more information see: www.recyclethis.info

INDUSTRY CANADA ICES-003 COMPLIANCE

This device meets the CAN ICES-3 (B)/NMB-3(B) standards requirements.

LIST OF CONTENTS

TITLE	PAGE
Safety Summary	5
1. GENERAL INFORMATION	7
1.1 System Description	7
1.2 Optional Equipment	8
1.3 Key Features	8
2. OPERATING INSTRUCTIONS	9
2.1. Basic Operations	9
2.2 Main Function	15
2.3 Client Software Introduction	29
3. MAINTENANCE	30
3.1 Maintenance	30
3.2 Troubleshooting	31
4. WARRANTY INFORMATION	32
4.1 Warranty Information and Registration	32
5. SPECIFICATIONS	34
5.1 Specifications	34

SAFETY SUMMARY

- Read and follow all instructions
- Read all warnings
- Only use the attachments/accessories specified by the manufacturer
- All service must be provided by the manufacturer

WARNINGS:

- **This product contains natural rubber latex, which may have the potential to cause allergic reactions. If you are allergic to latex, it is important that you strictly avoid exposure to products that contain it.**
- Always make sure your firearm is unloaded before you place the optic on the firearm. Reconfirm that the chamber is empty if you are forced to stop at anytime before completing the zeroing in process. Safe handling rules should be followed at all times.
- If a scope is mounted too far to the rear, the eyepiece may cause an impact injury to the shooter's eye socket. Shooting at an uphill angle also increases this hazard because it shortens the distance between the eyebrow and the rear of the scope. For this reason, AGM scopes are engineered to provide generous eye relief. Therefore, when mounting your scope, we recommend positioning it as far forward in the mounts as possible to take full advantage of this generous eye relief. With hard-recoiling rifles, serious injury or even death can result from eyepiece impact with the shooter during the recoil process when discharging the firearm. Be certain that your installation provides sufficient eye relief for the recoil generated by your rifle before shooting the firearm.

NOTES:

Give special attention to this warning when shooting uphill and/or from a prone position. These shooting conditions can dramatically reduce eye relief. PLEASE maintain maximum eye relief when shooting heavy recoiling and/or magnum firearms. THE USER ASSUMES ALL RESPONSIBILITY AND LIABILITY FOR HAVING THE AGM SCOPE PROPERLY MOUNTED TO A FIREARM AND USING THE AGM SCOPE PROPERLY. ALWAYS CHECK THE CONDITION OF YOUR MOUNTING SYSTEM PRIOR TO USING YOUR FIREARM.

- Proper usage of the device is crucial for safe operation, so make sure to carefully read this manual.
- If the device was left in storage for a longer period of time, before use, check its functionality.
- Disassembling of the device is prohibited and will invalidate the product warranty. Disassembly of any kind should only occur at AGM repair facilities.
- The external optical surfaces should be clean at all times. Touching the optical surfaces with bare hands is not recommended.
- Sand and sea water can damage the optical coatings.
- Do not point the device directly at the sun as it may damage the display.

- Thermal imagery is highly dependent on different scenery and atmospheric conditions. The same scenery may differ slightly in its appearance to the user, based on the time of day or night the optic is being used. This is the result of the level of heat absorption of different objects, which will vary based on the sun's placement in the sky at the time of use. The contrast of live animals will be more evident depending on the difference in surrounding air temperature and humidity levels.
- It is always recommended to store the unit with batteries removed, when not in use. Recharging the batteries every 2-3 months will help to extend their charging reliability.
- It is recommended to store the device with the lens cap closed at all times.
- Occasionally, extreme temperature shifts may cause condensation to form on the outer germanium lens. In this scenario, use a soft cloth to gently wipe the lens clean. As the unit becomes acclimates to the outer temperature, condensation should dissipate.

NOTES:

- The detector spectral band provides better visibility through smoke, dust, rain, smog, etc.
- Infrared radiation does not travel through glass. As a result, the clip-on does not detect objects if they are behind glass windows or other barriers.

LASER CAUTION:



When any laser equipment is in use, make sure that the device lens is not exposed to the laser beam, or it may burn out. The laser radiation emitted from the device can cause eye injuries, burning of skin or inflammable substances. Before enabling the light supplement function, make sure no human or inflammable substances are in front of the laser lens. Do not place the device where minors can fetch it.



IEC 60825-1: 2014
EN 60825-1: 2014 + A11: 2021

Complies with FDA performance standards for laser products except for conformance with IEC 60825-1 Ed. 3., as described in Laser Notice No. 56, dated May 8, 2019.

1 GENERAL INFORMATION

1.1 SYSTEM DESCRIPTION

The Secutor LRF-C is a compact thermal imaging clip-on system with built-in precision laser rangefinder (LRF) that allows quick transformation of the day optics into thermal imaging device without any special tools or equipment. Equipped with a highly sensitive, $12\mu\text{m}$ thermal detector and 1024×768 OLED monitor, the AGM Secutor LRF-C provides a clear image under harsh environmental conditions including darkness, fog, smoke, dust, rain, snow, brush, camouflage, etc. The user-friendly interface, comfortable and ergonomic operating controls makes Secutor LRF-C use incredibly easy. The Secutor LRF-C can easily be attached in front of day scopes with magnification up to 10x for medium range use.

The built-in laser range finder of the AGM Secutor LRF-C is designed to determine the exact distance between the observer and the target. Measurement results are displayed in the scopes monitor. Four replaceable CR123 Lithium batteries give the device over 6 hours of continuous operation time. An external 5V power bank (battery pack) can be easily connected via a USB to USB-C connector for a significant increase of operating time. The device is equipped with fast EMMC storage for on-board video/audio recording and image capture. Onboard Wi-Fi module allows live video streaming and video/image recording via mobile applications.

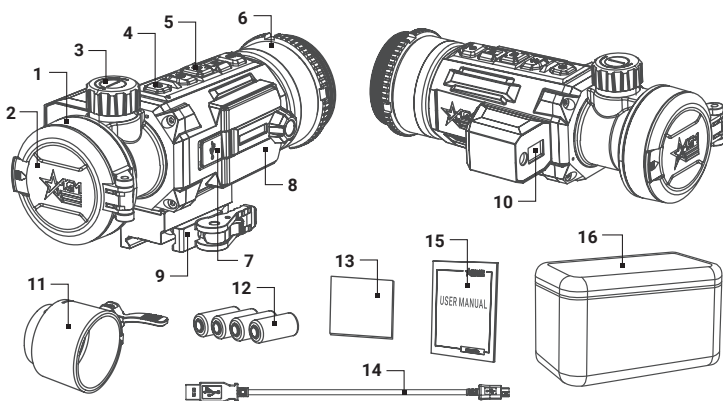

FIGURE 1-1. MAIN PARTS AND COMPONENTS

TABLE 1-1. MAIN PARTS AND COMPONENTS

ITEM	DESCRIPTION	ITEM	DESCRIPTION
1	Objective Lens	9	Picatinny Mount*
2	Objective Lens Cover	10	Laser Range Finder
3	Objective Focus Ring	11	Front Mount*
4	Power Button	12	CR123 Battery (4)
5	Operation Buttons	13	Lens Tissue
6	Output Lens Assembly	14	USB Cable
7	USB Type-C Interface	15	User Manual
8	Battery Compartment	16	Carrying Case

* Mounting kit depends on the region of sale.

1.2 OPTIONAL EQUIPMENT

Optional items are shown in Figure 1-2 and listed in Table 1-2.

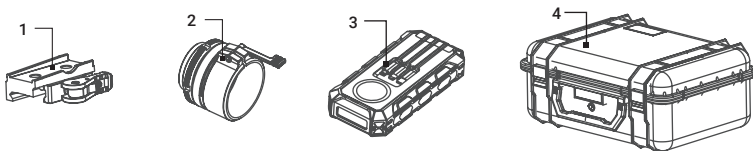

FIGURE 1-2. OPTIONAL EQUIPMENT

TABLE 1-2. OPTIONAL EQUIPMENT

ITEM	DESCRIPTION	PART NO.
1	AGM-2124 ADM QR Mount	6306X1241
2	Front Q-R Adapter for Rattler TC: ARM52-56	6306RC61
	Front Q-R Adapter for Rattler TC: ARM52-50	6306RC51
	Front Q-R Adapter for Rattler TC: ARM52-44	6306RC41
	Front Q-R Adapter for Rattler TC: ARM52-30	6306RC31
3	AGM Power Bank 30,000 mAh	6628XPB31
4	Hard Case for Storage/Transportation	6610HCS1

1.3 KEY FEATURES

- Quick conversion of daytime optics into thermal imaging scope
- 12 μ m thermal detector
- High sensitivity (NETD less than 20 mK)
- Fast 50Hz imaging
- Built-in laser rangefinder
- Adjustable color palettes
- High resolution OLED display
- On-board video/audio recording and image capture
- Built-in EMMC storage (16 GB)
- Wi-Fi data transmission
- Standby mode
- Over 6 hours of battery life
- External power supply compatibility
- Waterproof & shockproof

2 OPERATING INSTRUCTIONS

2.1. BASIC OPERATIONS

2.1.1 UNPACKING

The following steps must be completed prior to each use.

1. Open the carrying case, remove the device, and verify that all components are included.
2. Inspect the device for any signs of damage to the optical surfaces, body, eyecup, operation buttons, etc. Ensure that all optical surfaces are clean and ready for use. Once the diopter is set, all focusing of the image upon use of the digital zoom will occur via the lens focus knob, which is the rotating knob closest to the objective lens of the scope.

2.1.2 BATTERY INSTALLATION

CAUTION:

Verify that the device is turned off before removing the battery.

To install the battery (refer to Figure 2-1):

1. Turn the battery cover knob (A) counter clockwise and then open the battery cover (B).
2. Insert the batteries (C) into the battery compartment (D) with the positive mark inward.
3. Close the battery cover, and turn the battery cover knob clockwise.

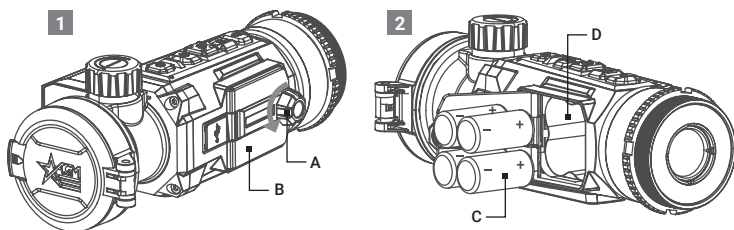



FIGURE 2-1. BATTERY INSTALLATION

NOTE

See the battery icon on the device display to check the battery charge. Icon  means the battery is fully charged, and icon  means that the battery is low. When the low power note shows, replace the batteries.

2.1.3 CONTROL BUTTONS

The Secutor LRF-C controls are shown in Figure 2-2 and are defined in Table 2-1.

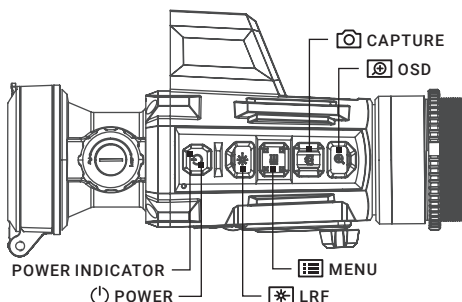







FIGURE 2-2. CONTROL BUTTONS

Each button is responsible for some functions selected by short press or long press of the button. Pushing a button for 3+ second is considered “long press/hold.”

TABLE 2-1. BUTTON FUNCTIONS

BUTTON	FUNCTIONS
 POWER	Press: Standby Mode/Wake Up Device Hold: Power On/Off
 MENU	Press: Enter the Quick Menu Hold: Enter the Main Menu MENU MODE Press: Confirm/Set Parameters Hold: Exit the Menu
 LRF	Press: Measuring Distance with LRF Hold: Image Calibration (FFC) MENU MODE Press: Up/Change Parameters
 CAPTURE	Press: Image Capture Hold: Start/Stop Video Recording MENU MODE Press: Down/Change Parameters
 OSD	Press: Clear/Display OSD information

2.1.4 POWER ON AND OFF

Power On

With the battery installed, press and hold the POWER button  to turn on the device. The LED power indicator in the POWER button will light up.

Power Off

When the device is turned on, hold the POWER button  to turn off the device.

Auto Power Off

In the “Auto Power Off” submenu of General Settings you can set the time for the automatic shutdown of the device as required (see 2.2.27 for details).

The Auto Power Off countdown will start again when the device exits standby mode, or the device is restarted.

2.1.5 STANDBY MODE

Standby mode is used to save battery power. In this mode, some power-consuming features such as the display, network hardware, or internal storage will be temporarily disabled.

In the view mode, press the POWER button . After a few seconds, the display will turn off. Press the POWER button  again to exit the Standby mode.

2.1.6 VIEWING THE THERMAL IMAGE

1. Install the Secutor LRF-C with a day scope (refer to part 2.1.12 or 2.1.13). Verify that the clip-on is securely mounted.
2. Remove the protective caps.
3. Point the equipment at an object.
4. Activate the Secutor LRF-C.
5. If the day scope includes a focusing ring (i.e., parallax adjustment knob), adjust the focus for a parallax-free image.
6. Turn on the day scope’s reticle illumination and adjust the reticle brightness.
7. Adjust the focus of Secutor LRF-C by turning the focus ring.
8. Configure the Secutor LRF-C for your specific situation. Set display mode, brightness, contrast to display the best image effect.

For more information on operational setting procedures, see Part 2.2 (Main Functions).

2.1.7 ON-SCREEN DISPLAY

On-screen interface displays the menu items and device status indicators.

Use the MENU button  in the view mode to display or hide the menu.

Press the OSD button  in the view mode to display or hide the On-Screen Display (OSD) information.

Adjust the On-Screen Display (OSD) in Function Settings menu (see 2.2.21).

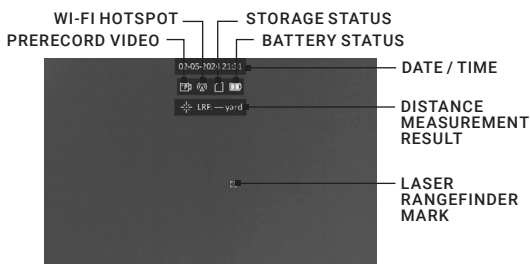



FIGURE 2-3. ON-SCREEN DISPLAY

When OSD is on, the information of Wi-Fi hotspot activation, storage memory status, battery status, time and date displays on the screen.

2.1.8 DISTANCE MEASUREMENT

The device can detect the distance between the target and the observation position with built-in laser rangefinder.

Make the laser rangefinder settings in the menu (see details in part 2.2.7). Point the square mark of the rangefinder at the target and press the LRF button  to measure the distance to the target. The distance measurement result is displayed at the upper part of the image.

2.1.9 VIDEO RECORDING AND IMAGE CAPTURE

Video Recording

Hold the CAPTURE button  in the view mode and start recording. In the upper left corner, the recording time displays.

Hold the CAPTURE button  again to stop recording.

Image Capture

Press the CAPTURE button  in the view mode, to capture the image.

NOTE:

- When captured, the image freezes for 1 second and a prompt shows on the display.

2.1.10 CONNECTING THE DEVICE

1. Open the cable interface cover.
2. Connect the device and power adapter with a Type-C cable to power on the device. Alternatively, connect the device and PC to copy/delete files.

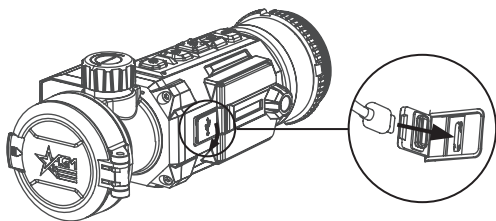

FIGURE 2-4. CABLE INTERFACE

2.1.11 FILE EXPORT

1. Before connecting the thermal clip-on to a computer, please make sure that the Wi-Fi function of the clip-on is disabled.
2. Connect the thermal clip-on to your PC with USB cable and open the detected disk.
3. The directory is named by the current date. Enter DCIM > "Date" to view the videos and snapshots.
 - Select and copy the videos to PC and play the file with the player.
 - Select and copy the snapshots to PC and view the files.
4. Disconnect the device from your PC.

NOTE:

- The device displays images when you connect it to PC. But functions such as recording, capturing and hot spot are disabled.
- When you connect the device to PC for the first time, it installs the driver automatically.

2.1.12 INSTALLING THE CLIP-ON ONTO THE LENS OF A DAY SCOPE

WARNING:

Always make sure your firearm is unloaded before you place the scope on the firearm. Reconfirm that the chamber is empty if you stop the procedure then resume later. Safe firearms handling rules should be followed at all times.

Use the front adapter to install the Secutor LRF-C onto day scope lenses. Select an adapter based on the outer diameter of the daytime objective.

NOTE:

The Secutor LRF-C cannot be attached to scopes that include focus rings on the housing of the objective lens.

NOTE:

The adapter must fit with the diameter of the day scope front lens. There are various optional day scope front adapters available for a wide range of objective lens diameters.

Before installing the front adapter onto the day scope, it is recommended to degrease the scope lens body and the inside surface of the adapter.

Install the Front Q-R adapter to the Secutor LRF-C as follows (refer to Figure 2-5):

1. Rotate the adapter (A) clockwise until it tightened securely.
2. Use the wrench in the package to tighten the fixing ring (B) until the adapter is fixed on the device.

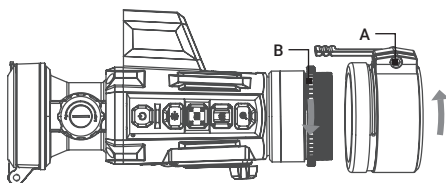

FIGURE 2-5. FRONT Q-R ADAPTER INSTALLATION

NOTE:

The thread size is M52 × 0.75 mm. Purchase the adapter recommended by the manufacturer.

NOTE:

Different models of front adapters may have different designs. Refer to the user manual for your adapter for correct installation.

Install the clip-on on the lens of a day scope as follows (refer to Figure 2-6):

1. Turn the lever (A) of adapter (B) backwards to loosen the adapter clamping device.

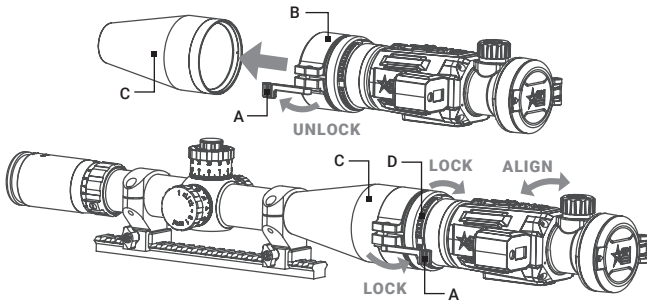

FIGURE 2-6. CLIP-ON INSTALLATION

2. Slide the Secutor LRF-C with the adapter onto the lens of the day scope (C) as far as it goes.
3. Affix the clip-on to the day scope by locking the lever (A) of adapter.
4. Rotate the clip-on to align its vertical position. Tighten the lock nut (D) tightly with the special wrench to secure the position.
5. Verify that the clip-on is firmly secured to the day scope. If there is play or if the adapter rotates on the scope lens when the lever is tightened, adjust the lever:
 - 1) Loosen the locking screw (Fig.2.7, A) on the side of mount with the hex-nut wrench (1.5mm).
 - 2) Tighten the adjustment screw (Fig.2.7, B) of lever with a clamping force necessary to ensure that the adapter fits tightly the objective lens.
 - 3) Tighten the locking screw (A).

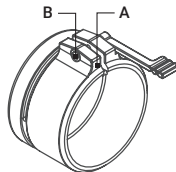

FIGURE 2-7. FRONT ADAPTER LEVER ADJUSTMENT

You may need to zero the day sight and attached clip-on. To maintain zeroing accuracy for future use, you can use the following method. When the clip-on is not used, simply loosen the fixing ring of the clip-on (Fig. 2-5, B) and remove the clip-on. At the same time, the front adapter remains on the sight lens, ensuring that the exact position of the clip-on is maintained after zeroing. The next time you use the clip-on, simply attach it to the adapter with the fixing ring according to the installation instructions.

NOTE:

AGM recommends that you use an eyecup on the day scope's eyepiece for maximum safety and comfort, as well as to escape detection.

2.1.13 INSTALLING THE SECUTOR LRF-C ON A PICATINNY/WEAVER RAIL

WARNING:

Always make sure your firearm is unloaded before you place the scope on the firearm. Reconfirm that the chamber is empty if you stop the procedure then resume later. Safe firearms handling rules should be followed at all times.

A Picatinny/Weaver mount is secured to the Secutor LRF-C with two screws (Fig. 2-8, A). The recommended tightening torque for the fixing screws is 4-5.3 Nm (5.44-7.2 ft lb).

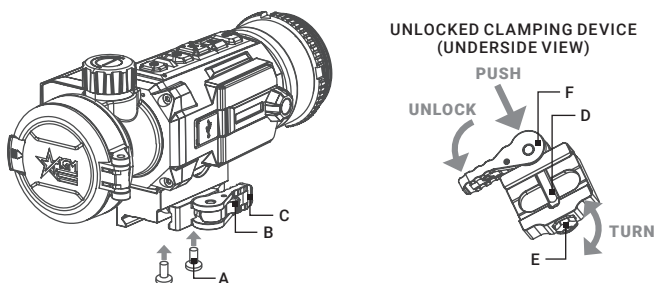

FIGURE 2-8. MOUNT

To install the Secutor LRF-C on a Picatinny/Weaver rail, perform the following:

1. Unlock the clamping device of the clip-on mount by pushing down on the lever holder (Fig. 2-8, B) and unlocking the lever (C).
2. Install the clip-on on the Picatinny/ Weaver rail so that the stop (D) slides into the transverse slot on the rail.
3. Affix the clip-on to the rail by locking the lever (C).
4. Verify that the clamping device is firmly holding the Secutor LRF-C. If necessary, adjust the clamping device's lever-cam lock as detailed in part 2.1.14.

2.1.14 CLAMPING DEVICE ADJUSTMENT

To adjust the mount's clamping device, do the following:

1. Remove the Secutor LRF-C from the rail.
2. With the clamping device unlocked (as shown in Figure 2-8), push the cam (F) towards the arrow, which will cause the nut (E) to slide out of its hole.
3. To tighten/ loosen the clamping device, push down on the cam (F) and turn the nut (E) CW/ CCW respectively, in one-two increments (see note below). Much like when the cam (F) is released, backward-moving spring will cause the nut (E) to slide back into its hole.

NOTE:

The eight-sided nut of the mount lever-cam lock will only fit into their hole if turned in one of the discrete positions, using increments equal to $360^\circ/8$.

4. Verify that the adjusted lever-cam lock securely holds the mounting rail.

2.2 MAIN FUNCTIONS

2.2.1 QUICK MENU

In the live view mode, press  to show the Quick Menu. You can set parameters such as **Mode** (Palette Settings), **Display Brightness** and **Contrast** in the quick menu.

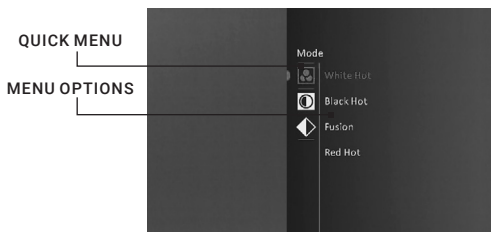

FIGURE 2-9. QUICK MENU

2.2.2 PALETTE SETTINGS

You can select different palettes to display the same scene in different effects.















1. Press the MENU button  to show the Quick Menu.
2. Press  or  button to select the  **Mode** menu item and press the MENU button  to confirm.
3. Press  or  button to select a mode (image palette) and press the MENU button  to confirm.

TABLE 2-2. PALETTE SETTINGS







PALETTE	DESCRIPTION
WHITE HOT	The hot part is displayed in white. The higher the temperature, the lighter the color.
BLACK HOT	The hot part is displayed in black. The higher the temperature, the darker the color.
FUSION	The hot part is displayed in white. From high temperature to low temperature, the image is colored in from white, yellow, red, pink to purple.
RED HOT	The hottest part is displayed in red, the rest of the image will be flushed out in shades of gray.

4. Hold the MENU button  to exit a menu.

2.2.3 BRIGHTNESS ADJUSTMENT

1. Press the MENU button  in live view interface to call the Quick Menu, then select the  **Brightness** menu item and press the MENU button  to confirm.
2. Press  or  button to adjust the brightness. You can select one of ten levels of the brightness to adjust the image lighter or darker.
3. Hold the MENU button  to exit a menu.

2.2.4 CONTRAST ADJUSTMENT

1. Press the MENU button  in live view interface to call the Quick Menu, then select the  Contrast menu item and press the MENU button  to confirm.
2. Press  or  button to adjust the image contrast. You can select one of ten levels of the contrast.
3. Hold the MENU button  to exit a menu.

2.2.5 MAIN MENU OPERATION

Hold the MENU button  in the view mode to display the Main Menu.

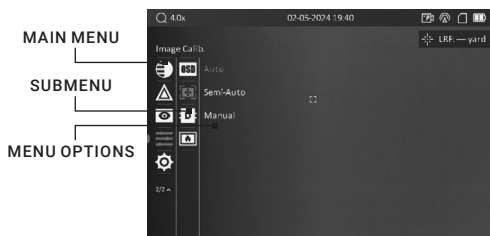

































FIGURE 2-10. MAIN MENU



Press  or  buttons to move between menu items. The active element is highlighted. Press the MENU button  to select menu item or change an option.

Hold the MENU button  to save settings and exit the menu.

TABLE 2-3. MENU FUNCTIONS







MENU ITEM	SYMBOL	OPTION	FUNCTION
NETWORK		Close / Hotspot	Enables or disables the Wi-Fi hotspot.
LASER RANGING		Close / Once / Continuous (15s, 30s, 60s, 120s, 300s)	Enables or disables built-in laser rangefinder. Distance measurement mode settings.
HOT TRACKING		OFF / ON	Enables or disables hot spot mark (marking the spot of highest temperature).
ZEROING		Zeroing Menu:	
Zeroing		OFF / 1 / 2 / 3 / 4 / 5	Zeroing settings selection or disable reticle.
Distance		Distance	Setting the distance to the target.
Type		10 Reticle Type	Setting the reticle type.
Color		4 Reticle Colors	Setting the reticle color (black, white, red, green).

MENU ITEM	SYMBOL	OPTION	FUNCTION
Freeze Screen		OFF / ON	Image freeze.
X Axis		Reticle Position X	Setting the X-axis correction.
Y Axis		Reticle Position Y	Setting the Y-axis correction.
COMPASS		OFF / ON	Enables or disables Compass. Magnetic declination correction.
PRERECORD		OFF / ON	Device can automatically record the 7 seconds before and after the recoil activation.
AUDIO		OFF / ON	Enable or disable audio recording.
TONE		Cold / Warm	Switch between the Cold mode and Warm mode.
SHARPNESS		5 Levels of Sharpness	Adjusts the image sharpness.
SCENE MODE		Recognition / Jungle	Switch between the Recognition mode and Jungle mode.
FUNCTION SETTINGS		Function Settings Menu:	
Image Calibration		Reference Line ON/OFF. Image Position	Helps to solve the problem of shooting deviation and to achieve better accuracy.
OSD		OSD / Time / Date	Enables or disables OSD, time, date.
Image Calib.		Auto / Semi-Auto / Manual	Selecting the Flat Field Correction (FFC) mode.
DPC		Axis: X/Y	Correction of dead pixel manually.
Burn Prevention		OFF / ON	Enables or disables the Burn Prevention function.
GENERAL SETTINGS		General Settings Menu:	
Language		22 Languages	Choice of interface language.
Date		Month/Day/Year	Date setting.
Time		12 / 24 hour	Time setting.
Unit		yard / m	Sets the distance unit.
Auto Power Off		OFF / 15 min / 30 min / 45 min	Setting the automatic shutdown time.

MENU ITEM	SYMBOL	OPTION	FUNCTION
Restore		---	Restoring the default device settings.
Version		---	Firmware version and serial number.

2.2.6 NETWORK CONFIGURATION

Connect your phone to the Wi-Fi hotspot of the clip-on, you can configure the parameters and realize functions of the device.

1. Hold the MENU button  to show the menu.
2. Press  or  button to select  **Network** menu item and press the MENU button  to enable or disable Wi-Fi hotspot.
3. Hold the MENU button  to exit a menu.











Open the AGM Connect APP and connect your phone with the device (refer to Section 2.3). You can view the interface of clip-on on your phone.

NOTE:

When the power is less than 15%, the Wi-Fi hotspot function will be turned off automatically.

2.2.7 SET LASER RANGING





The device can detect the distance between the target and the observation position with built-in laser rangefinder.

1. Hold the MENU button  to show the menu.
2. Press  or  button to select  **Laser Ranging** menu item and press the MENU button  to switch the laser ranging mode.
3. Press  or  button to select the laser ranging mode between **Close** (rangefinder disabled), **Once** and **Continuous (15s)**, **Continuous (30s)**, **Continuous (60s)**, **Continuous (120s)**, **Continuous (300s)**. Press the MENU button  to set selected mode.
4. Hold the MENU button  to return to the live view interface.
5. When the Once mode is selected, point the square mark of the rangefinder at the target and press the LRF BUTton  to measure the distance to the target.
6. You can scan the surroundings under Continuous mode. Continuous distance scanning will occur for a set time of 15, 30, 60, 120 or 300 seconds after pressing the LRF button .

The distance measurement result is displayed at the upper right of the image.

2.2.8 HOT TRACKING

The device can detect the highest temperature spot in the scene and mark it on display.

























1. Hold the MENU button  to show the menu.
2. Press  or  button to select  **Hot Tracking** menu item and press the MENU button  to enable/disable hot spot mark (marking the spot of highest temperature).

3. Hold the MENU button  to exit a menu.

When the hot spot mark is enabled, the green cross mark  displays in the spot of the highest temperature. When the scene changes, the green mark moves.

2.2.9 ZEROING

You can enable or disable the reticle and set options such as type, color, and position correction (coordinates) in the current zeroing profile. The reticle can be used to correctly position the clip-on relative to the scope when using the front adapter (see 2.2.30 for details).

1. Hold the MENU button  to show the menu.
2. Press  or  button to select  **Zeroing** menu item and press the MENU button  to enter the zeroing setting interface. Press  or  buttons to move between submenu and options.
3. Press  or  to select  **Zeroing No.** You can select **OFF** to disable the reticle.
4. Set reticle type (for parameters of all built-in reticles, see part 5.3).
 - 1) In the zeroing setting interface press  or  button to select  **Type** submenu and press the MENU button  to confirm.
 - 2) Press  or  button to select a reticle type and press the MENU button  to confirm.
5. Set reticle color.
 - 1) In the zeroing setting interface press  or  button to select  **Color** submenu and press the MENU button  to confirm.
 - 2) Press  or  button to select black, white, red or green color of reticle and press the MENU button  to confirm.





NOTE:

In **Black Hot mode** and **White Hot mode**, if you set the reticle color as **white** or **black**, the reticle colors can be automatically inverted depends on thermal image around the reticle.

6. (Optional) Repeat 3 to 5 to set type and color for other reticles in this profile.
7. Hold the MENU button  to save and exit.

2.2.10 COMPASS

Equipped with a compass, the device is able to display its direction on the live image, captured images, and recorded videos.

1. Hold the MENU button  to show the menu.
2. Press  or  button to select  **Compass** menu item and press the MENU button  to enter the Compass setting interface, then follow the pop-up instructions to calibrate the compass. See part 2.2.11 for more information.

After successful calibration, you can see the direction displayed at up right corner of the screen. It is recommended to read the direction when you lay the device horizontally.

To increase the direction accuracy, you can set the magnetic declination correction. See part 2.2.12 for instructions.

2.2.11 CALIBRATE COMPASS

Compass calibration is a must for correction direction display.

You need to calibrate the compass when you enable the function for the first time, or when the compass is magnetically interfered, and the direction information displays red.



1. Call the calibration guide by the following ways.
 - When you enable compass for the first time, the compass calibration guide pops up.
 - When the compass information displays red, select  Compass in menu mode and press the MENU button  to re-enable compass.
2. Follow the screen instructions to move and rotate the device.



FIGURE 2-11. DIGITAL COMPASS

NOTE:









During calibration, keep moving and rotating the device to make sure that the device faces every possible directions.

Calibration Level indicates the validity of calibration. Higher level means more accurate compass reading. Calibration succeeds when the Calibration Level turns to 3.

3. Stop moving the device when calibration success message pops up.
The direction information is displayed on the up right of the live view image.







2.2.12 MAGNETIC DECLINATION CORRECTION

Magnetic declination is the angle variation between magnetic north and true north. Adding the magnetic declination to the compass increase the accuracy of direction reading.

1. After the compass is calibrated, go to the compass setting interface, and press  or  button to select Magnetic Declination.
2. Press the  or  button to select Quick Correction or Manual Correction.
 - In **Quick Correction**, the device display the current declination to magnetic north. Point screen center to true north and press the MENU button .
 - In **Manual Correction**, press the MENU button  to select the operational symbol or number, and then press the  or  button to add or subtract the declination of device location.

2.2.13 PRERECORD VIDEO

After enabling the Shot Activated Recording (SAR) function, the device will automatically start recording 7 seconds before the recoil-activation and end recording 7 seconds after the recoil-activation.







1. Hold the MENU button  to show the menu.
2. Press  or  button to select  Prerecord menu item.
3. Press the button  to switch ON/OFF SAR function.
4. Hold the MENU button  to exit a menu.

NOTE:

For exporting recorded files, refer to Export Files (part 2.1.11).









2.2.14 AUDIO RECORDING SETTING

The Audio function allows you to record sound along with video. If there is too much noise when recording, this function can be disabled.

1. Hold the MENU button  to show the menu.
2. Press  or  button to select  Audio menu item, and press the MENU button  to enable or disable this function.
3. Hold the MENU button  to exit a menu.









2.2.15 IMAGE TONE SETTING

This function allows you to change the tone of thermal image to warm or cold.

1. Hold the MENU button  to show the menu.
2. Press  or  button to select  Tone menu item and press the MENU button  to confirm.
3. Press  or  button to select Warm or Cold tone.
4. Hold the MENU button  to exit a menu.







2.2.16 SHARPNESS SETTING

This function allows you to adjust the sharpness of the thermal image.

1. Hold the MENU button  to show the menu.
2. Press  or  button to select  Sharpness menu item and press the MENU button  to confirm.
3. Press  or  button to adjust the image sharpness.
4. Hold the MENU button  to exit a menu.

2.2.17 SCENE MODE

You can select proper Scene Mode according to environment temperature to improve the display effect.

1. Hold the MENU button  to show the menu.
2. Press  or  button to select  Scene Mode menu item and press the MENU button  to confirm.
3. Press  or  button to switch scene mode:

Recognition mode: improves an image so that the object edge is more distinct.

Jungle mode: is more suitable for hunting environment because of the highlight function of small objects.

4. Hold the MENU button  to exit a menu.

2.2.18 CALIBRATE IMAGE

After mounting of clip-on to the rail with day scope the clip-on optical axis can be offset off scope optical axis. The Calibrate Image function supports manually adjusting the position of the digital scope view window on the screen and allows you to compensate for the offset. The image region can be adjusted in 4 directions in the whole screen area. This way the device can adjust the view to make it consistent with the optical view.

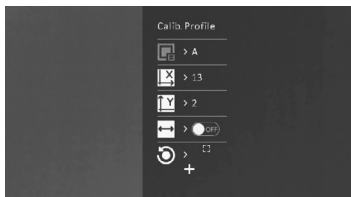

FIGURE 2-12. CALIBRATE IMAGE SUBMENU

1. Aim your day scope to the middle of target and shoot. This action will test the control of day scope accuracy.
2. Mount the clip-on to the day scope. Aim at the center of the target and shoot again.
3. Hold the MENU button to show the menu.
4. Press or to select **Function Settings** menu and press the MENU button to confirm.
5. Press or to select **Calibrate Image** submenu and press the MENU button to enter.
6. Select , and press to switch calib. profile. You can set 5 calib. profiles.
7. Select , and press to select X and Y axis, and press to confirm. Press and to set the coordinates until the window reaches the target position.
8. Select , and press to enable **Reference Line**. A horizontal reference line appears in the middle of the view. This line helps to align the position of the digital scope and day optics when using the front mount. Rotate the digital scope to align the reference line with the daylight reticle.
9. (Optional) Select **Restore**, and press to confirm. Select **OK** to restore the view to default position, and **CANCEL** to return to the setting interface.













NOTE:

The default position of image window may not be exactly at zero (X=0, Y=0). This is caused by slight individual differences of optical components, and it is a normal phenomenon.

10. Hold the MENU button to exit a menu.











2.2.19 ON-SCREEN DISPLAY (OSD)

You can choose which OSD information to display in the live view user interface. Options include, wi-fi hotspot activation, current magnification, memory storage status, battery indicator status, time and date. These will appear at the top of the display interface when activated.

1. Hold the MENU button  to show the menu.
2. Press  or  button to select  **Function Settings** menu and press the MENU button  to confirm.
3. Press  or  button to select  **OSD** submenu and press the MENU button  to enter.
4. Press  or  button to select the **OSD, Time or Date**. Press the MENU button  to display or hide the necessary information.
5. Hold the MENU button  to exit a menu.

2.2.20 IMAGE CALIBRATION

The image calibration function performs what is known as the Flat Field Correction or FFC. This is required of all thermal devices. This can correct for non-uniformity of the display. During correction an internal shutter will be lowered in front of the thermal detector. A “click” sound will often be heard, and the image is momentarily interrupted for a split second. After this quick process the detector will be re-calibrated, and the image becomes more accurate. AGM recommends automatic when scanning for game or targets. However, we recommend going into the menu and changing to Manual correction mode when getting close making your shot. This will prevent any unwanted auto-correction occurring when tracking live game. This will help shooters in making ethical shot placements at all times.

1. Hold the MENU button  to show the menu.
2. Press  or  button to select  **Function Settings** menu and press the MENU button  to confirm.
3. Press  or  button to select  **Image Calib.** submenu and press the MENU button  to enter.
4. Press  or  button to switch the FFC mode.

Auto: The clip-on performs FFC automatically when switching on or rebooting the camera.

Semi-Auto: Hold the LRF button  in live view to correct the non-uniformity of display.









Manual: Cover the lens cap, then hold the LRF button  in live view to correct the non-uniformity of display.







5. Hold the MENU button  to exit a menu.

2.2.21 DEFECTIVE PIXELS CORRECTION

The Defective Pixel Correction (DPC) can help users repair the occasional deactivated pixel within the display. This is fairly common in thermal optics, which is why so many of these optics come equipped with a DPC feature. 1-3 dead pixels are usually easily repaired by the user. Anything over 3 that cannot be repaired, will open the unit up to an approved warranty repair by AGM at their facility.











Before you start switch the palette to White Hot mode.

1. Hold the MENU button  to show the menu.
2. Press  or  button to select  **Function Settings** menu and press the MENU button  to confirm.
3. Press  or  button to select  **DPC** submenu and press the MENU button  to enter.

4. Press  or  button to select the X or Y axis and press the MENU button  to confirm.
5. Press  or  button to set the coordinates until the cursor reaches the dead pixel.
6. Press the MENU button  to correct the dead pixel.
7. (Optional) Repeat 4 to 6 to correct the position for other dead pixels.
8. Hold the MENU button  to exit a menu.













2.2.22 BURN PREVENTION

This function can prevent damage to the thermal sensor from the sun or other high temperature bright light sources. When enabling this function, the shield will close until the environment turns to normal. This feature may be useful to help protect sensitive displays during extreme summer temperatures. AGM recommends all units be stored in room temperature whenever possible, as long periods of storage in extreme heat (such as inside a vehicle) may lead to issues with the display materials.















1. Hold the MENU button  to show the menu.
2. Press  or  button to select  **Function Settings** menu and press the MENU button  to confirm.
3. Press  or  button to select  **Burn Prevention** submenu and press the MENU button  to enable or disable the Burn Prevention function.
4. Hold the MENU button  to exit a menu.

2.2.23 LANGUAGE SETTING















You can select different languages of user interface.

1. Hold the MENU button  to show the menu.
2. Press  or  button to select  **General Settings** and press the MENU button  to confirm.
3. Press  or  button to select  **Language** submenu and press the MENU button  to enter.
4. Press  or  button to select the language as required and press the MENU button  to confirm.
5. Hold the MENU button  to exit a menu.

2.2.24 DATE SETTING











1. Hold the MENU button  to show the menu.
2. Press  or  button to select  **General Settings** and press the MENU button  to confirm.
3. Press  or  button to select  **Date** submenu and press the MENU button  to enter the configuration interface.
4. Press the MENU button  to select the month, day or year to be synchronized and press  or  button to change the number, then press the MENU button  again to finish the setting.
5. Hold the MENU button  to exit a menu.

2.2.25 TIME SETTING

1. Hold the MENU button  to show the menu.
2. Press  or  button to select  **General Settings** and press the MENU button  to confirm.
3. Press  or  button to select  **Time** submenu and press the MENU button  to enter the configuration interface.
4. Press the MENU button  to select the hour, minute, second to be synchronized and press  or  button to change the number, then press the MENU button  again to finish the setting.
5. Hold the MENU button  to exit a menu.













2.2.26 UNIT SETTING

You can set the unit (yards or meters) of measurement for distance.

1. Hold the MENU button  to show the menu.
2. Press  or  button to select  **General Settings** and press the MENU button  to confirm.
3. Press  or  button to select  **Unit** submenu and press the MENU button  to enter the configuration interface.
4. Press the MENU button  to select Yard or Meter.
5. Hold the MENU button  to exit a menu.









2.2.27 AUTO POWER OFF

You can set the time for the automatic shutdown of the device as required.

1. Hold the MENU button  to show the menu.
2. Press  or  button to select  **General Settings** and press the MENU button  to confirm.
3. Press  or  button to select  **Auto Power Off** submenu and press the MENU button  to enter the configuration interface.
4. Press  or  button to select OFF, 15 min, 30 min or 45 min and press the MENU button  to confirm.
5. Hold the MENU button  to exit a menu.









2.2.28 RESTORE DEVICE

You can reset the settings of device.

1. Hold the MENU button  to show the menu.
2. Press  or  button to select  **General Settings** and press the MENU button  to confirm.
3. Press  or  button to select  **Restore** and press the MENU button . The window "Initialize?" will appear.
 - **OK**: Restore the device to defaults.
 - **CANCEL**: Exit without changing the settings.

2.2.29 VERSION

You can view the device information such as firmware version and serial number.

1. Hold the MENU button  to show the menu.
2. Press  or  button to select  **General Settings** and press the MENU button  to confirm.
3. Press  or  button to select  **Version** item and press the MENU button  to confirm. The firmware version and serial number will be displayed.

2.2.30 QUICK POSITIONING OF CLIP-ON WITH FRONT MOUNT

When using the front adapter, you can quickly remove and install the clip-on on the day scope. In order to obtain the correct position the next time the clip-on is installed without additional zeroing, it is recommended to perform the following steps after calibrate the image (paragraph 2.2.18).

1. Enter the menu and select  **Zeroing** menu (paragraph 2.2.9).
2. Turn on reticle display.
3. Move the clip-on reticle and align it with the day scope mark.
4. Save the clip-on reticle position setting.

The next time the clip-on is mounted on the scope, look into the eyepiece of the scope and, with the front adapter lever loosened, move the attachment so that the clip-on reticle is again aligned with the scope mark. Tighten the adapter lever. Turn off the display of the clip-on reticle and use the day scope reticle to aim at the target.

2.3 CLIENT SOFTWARE INTRODUCTION

Search the AGM Connect software in App Store (iOS System) or Google Play™ (Android System) and install the application on your mobile phone. Turn on the Wi-Fi hotspot on the thermal device and then connect your phone to the hotspot.



- Hotspot Name: Wlan-<Serial No.>

- Hotspot Password: Last 9 digits of Serial Number of your thermal scope.

NOTE:

The device password is set by user at first activation. If the password was lost or forgotten, it can be reset. To reset a password perform the following steps:

1. When the thermal device is turned on, hold the MENU button  to activate the Main menu.

2. Select  Restore item in the General Settings menu and press the MENU button  to restore all parameters to default settings.

1. Run the app and connect the phone or tablet with the device.

2. If the device is inactivated, set the password and activate it. If the device is activated, enter the password to add it to the app.

3. When the device is added, the live view can be seen. You can view the interface of the device on the software. User can change such image parameters as brightness, contrast, zoom, palettes directly via phone or tablet as well as record video on phone/tablet memory.

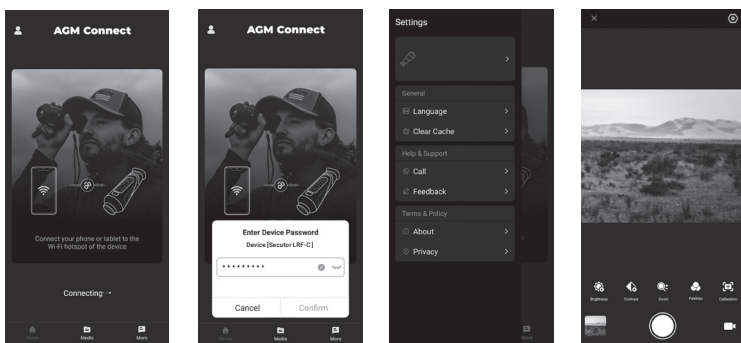

FIGURE 2-13. AGM CONNECT APP

3 MAINTENANCE

3.1 MAINTENANCE

3.1.1 CLEANING PROCEDURES

1. Gently brush off any dirt from the body of the device using a clean, soft cloth.
2. Moisten the cloth with fresh water and gently wipe down the external surfaces (except lenses).
3. Dry any wet surfaces (except lenses) using another dry, clean, soft cloth.
4. Using a lens brush, carefully remove all loose dirt from the lenses.
5. Use a high quality lens wipe to remove dirt or smudges from the lens and display window. Do not use abrasives or solvents to clean the housing, lens, or display window. Clean the glass surfaces using circular movements, starting from the center of the lens and moving out towards the edge.
6. Clean the accessories with a soft brush (or cloth) dampened with soap and water.

3.1.2 PREPARING FOR EXTENDED STORAGE

CAUTION:

Thoroughly dry each item before placing them into the storage case.

To prepare the clip-on for extended storage:

1. Clean the clip-on with a damp cloth to remove any dust, dirt or debris.
2. Remove the batteries.
3. Close the lens cap, and place items into their soft carrying case.

3.1.3 UPDATING THE DEVICE FIRMWARE

WARNING:

Please make sure the device is connected to the computer during the entire update process. Otherwise, it may cause unnecessary upgrade failure, firmware damage, etc.

1. Visit www.agmglobalvision.com/firmware website. Select your product, download the firmware update package to your PC and unzip it. Follow the detailed instructions on the website.
2. Connect the device to your PC with USB cable.
3. Turn on the device. Make sure the Wi-Fi hotspot function is disabled.
4. Open the detected disk (USB drive) in file manager program. Copy the unzipped **digicap.dav** file and paste it to the root directory of the device.
5. Turn off the device completely, then power it back on. After awhile, the firmware update process will start automatically. During the update, the screen

will display the inscription “Upgrading...”. The update process will be completed when the inscription “Upgrading...” goes out.

6. Turn off the device and disconnect it from your PC.

You can also enjoy automatic update function in AGM Connect App (see section 2.3 for details).

1. Start the AGM Connect App and tap the Settings icon in the left top corner.

2. Tap your device in the device list. The information about your device will be shown.

3. Tap **Checking for Upgrade** to detect and download the latest FW version.

3.2 TROUBLESHOOTING

Table 3-1 lists the most common malfunctions that may occur with your equipment. This table does not list all the malfunctions that may occur with your device. If the equipment malfunction is not corrected by the suggested actions, or a problem occurs that is not listed in this table, please contact AGM Global Vision’s Customer Support center or your retailer.

TABLE 3-1. TROUBLESHOOTING

MALFUNCTION	CORRECTIVE ACTION
The scope fails to activate.	<ol style="list-style-type: none">1. Batteries are missing or improperly installed. Insert batteries or install correctly.2. Batteries are dead. Replace the batteries.3. Batteries, surfaces or contacts are dirty or corroded. Clean the contact.
The clip-on shut off sometimes after shot.	<ol style="list-style-type: none">1. Low battery level. Check the remaining capacity of the batteries, which may be low on power to maintain performance. Replace the batteries.
The image is not clear.	Perform the sight adjustment referring to section 2.1.
Wi-Fi is not found.	Examine whether the Wi-Fi function is turned on. If not, turn on the Wi-Fi hotspot in the menu.
Capturing or recording fails.	<ol style="list-style-type: none">1. The device is connected to your PC and has disabled the capturing and recording. Disconnect the device.2. The storage space is full. Delete old files.3. The device is in a low-battery condition. Replace the batteries.
The PC cannot identify the scope.	<ol style="list-style-type: none">1. The device is connected to your PC with standard USB cable. If you use other USB cables, make sure the cable length is no longer than 1 m.2. The Wi-Fi function is turned on. If so, turn off the Wi-Fi hotspot in the menu.

4 WARRANTY INFORMATION

4.1 WARRANTY INFORMATION AND REGISTRATION

The below description of AGM Global Vision warranty terms and conditions refer specifically to AGM branded products purchased within the United States. Customers purchasing AGM products outside the United States can obtain specific information about their product's warranty term on the www.agmglobalvision.eu website.

4.1.1 WARRANTY INFORMATION

This product is guaranteed to be free from manufacturing defects in material and workmanship under normal use for a period of five (5) years from the date of purchase. In the event that a defect covered by the warranty below occurs during the applicable period stated above, AGM Global Vision, at its discretion, will either repair or replace the product; such action on the part of AGM Global Vision shall be the full extent of AGM Global Vision's liability, and the Customer's sole and exclusive reparation. This warranty does not cover a product if it has been (a) used in ways other than its normal and customary manner; (b) subjected to misuse; (c) subjected to alterations, modifications or repairs by the Customer or by any party other than AGM Global Vision without prior written consent of AGM Global Vision; (d) is the result of a special order or categorized as "close-out" merchandise or merchandise sold "as-is" by either AGM Global Vision or the AGM Global Vision dealer; or (e) merchandise that has been discontinued by the manufacturer and either parts or replacement units are not available due to reasons beyond the control of AGM Global Vision. AGM Global Vision shall not be responsible for any defects or damage that in AGM Global Vision's view are a result from the mishandling, abuse, misuse, improper storage or improper operation of the device, including use in conjunction with equipment that is electrically or mechanically incompatible with, or of inferior quality to, the product, as well as failure to maintain the environmental conditions specified by the manufacturer. This warranty is extended only to the original purchaser. Any breach of this warranty shall be enforced unless the customer notifies AGM Global Vision at the address noted below within the applicable warranty period.

The customer understands and agrees that except for the foregoing warranty, no other warranties written or oral, statutory, expressed or implied, including any implied warranty of merchantability or fitness for a particular purpose, shall apply to the product. All such implied warranties are hereby and expressly disclaimed.

4.1.2 LIMITATION OF LIABILITY

AGM Global Vision will not be liable for any claims, actions, suits, proceedings, costs, expenses, damages, or liabilities arising out of the use of this product. Operation and use of the product are the sole responsibility of the Customer. AGM Global Vision's sole undertaking is limited to providing the products and services outlined herein in accordance with the terms and conditions of

this Agreement. The provision of products sold and services performed by AGM Global Vision to the Customer shall not be interpreted, construed, or regarded, either expressly or implied, as being for the benefit of or creating any obligation toward any third party of legal entity outside AGM Global Vision and the Customer; AGM Global Vision's obligations under this Agreement extend solely to the Customer. AGM Global Vision's liability hereunder for damages, regardless of the form or action, shall not exceed the fees or other charges paid to AGM Global Vision by the customer or customer's dealer. AGM Global Vision shall not, in any event, be liable for special, indirect, incidental, or consequential damages, including, but not limited to, lost income, lost revenue, or lost profit, whether such damages were foreseeable or not at the time of purchase, and whether or not such damages arise out of a breach of warranty, a breach of agreement, negligence, strict liability, or any other theory of liability.

4.1.3 PRODUCT REGISTRATION

In order to validate the warranty on your product, the customer must complete and submit AGM Global Vision PRODUCT REGISTRATION FORM on our website (www.agmglobalvision.com/customer-support).

4.1.4 OBTAINING WARRANTY SERVICE

To obtain warranty service on your unit, the End-user (Customer) must notify the AGM Global Vision service department via e-mail. Send any requests to support@agmglobalvision.com to receive a Return Merchandise Authorization number (RMA). When returning any device, please take the product to your retailer, or send the product, postage paid and with a copy of your sales receipt, to AGM Global Vision's service center at the address listed above. All merchandise must be fully insured with the correct postage; AGM Global Vision will not be responsible for improper postage or merchandise that becomes lost or damaged during shipment. When sending product back, please clearly write the RMA# on the outside of the shipping box. Please include a letter that indicates your RMA#, the Customer's Name, a Return Address, reason for the return, contact information (valid telephone numbers and/or an e-mail address), and proof of purchase that will help us to establish the valid start date of the warranty. Product merchandise returns that do not have an RMA# listed may be refused, or a significant delay in processing may occur. Estimated Warranty service time is 10-20 business days. The End-user/Customer is responsible for postage to AGM Global Vision for warranty service. AGM Global Vision will cover return postage/shipping after warranty repair to the End-user/Customer only if the product is covered by the aforementioned warranty. AGM Global Vision will return the product after warranty service by domestic UPS Ground service and/or domestic mail. Should any other requested, required, or international shipping methods be necessary, the postage/shipping fee will be the responsibility of the End-user/Customer.

For service, repair or replacement, please contact:

AGM Global Vision, LLC

173 West Main Street

PO Box 962

Springerville, AZ 85938

Tel. 928.333.4300

support@agmglobalvision.com

www.agmglobalvision.com

5 SPECIFICATIONS

5.1 SPECIFICATIONS

	SECUTOR LRF-C 50-640	SECUTOR LRF-C 75-640
Detector Type	12 μ m VOx Uncooled Focal Plane Array	12 μ m VOx Uncooled Focal Plane Array
Resolution	640 × 512	640 × 512
Refresh Rate	50 Hz	50 Hz
Response Waveband	8 μ m to 14 μ m	8 μ m to 14 μ m
NETD	Less than 20 mK (@25°C), F#=1.0	Less than 20 mK (@25°C), F#=1.0
Lens System	50 mm; F1.0	75 mm; F1.2
Field of View (H×V)	8.8° × 7.0°	5.9° × 4.7°
Magnification	1×	1×
Detection Range (6' object)	2,600 m/yd	3,800 m/yd
Exit Pupil	22 mm	22 mm
Monitor	1024x768, 0.39 inch, OLED	1024x768, 0.39 inch, OLED
FFC (Flat Field Correction)	Auto, Semi-Auto, Manual	Auto, Semi-Auto, Manual
Palettes	Black Hot, White Hot, Red Hot, Fusion	Black Hot, White Hot, Red Hot, Fusion
Laser Range Finder	Up to 1000 m, ±4 m accuracy	Up to 1000 m, ±4 m accuracy
Laser Wavelength	905 nm	905 nm
Laser Safety Class	Class 1	Class 1
Highest Temperature Spot Tracking	Yes	Yes
Defective Pixel Correction	Yes	Yes
WiFi Hotspot	Yes	Yes
Standby Mode	Yes	Yes
Burn Prevention	Yes	Yes

	SECUTOR LRF-C 50-640	SECUTOR LRF-C 75-640
Video/Audio Recording	Yes	Yes
Image Capture	Yes	Yes
Shot Activated Recording (SAR)	Yes	Yes
Built-in Storage	16 GB EMMC	16 GB EMMC
Battery Type	Four CR123A Lithium batteries	Four CR123A Lithium batteries
Battery Life (WiFi and LRF off)	More than 6 hours	More than 6 hours
External Power	5 VDC/2 A, USB Type-C	5 VDC/2 A, USB Type-C
Working Temperature	-30°C to 55°C (-22°F to 131°F)	-30°C to 55°C (-22°F to 131°F)
Protection Level	IP67	IP67
Max. Recoil	1,000 g / 0.4 ms	1,000 g / 0.4 ms
Dimensions (w/o mount)	193 × 104 × 74 mm (7.6 × 4.1 × 2.9 in)	228 × 111 × 81 mm (9 × 4.4 × 3.2 in)
Weight (w/o mount and battery)	0.63 kg (1.38 lb)	0.73 kg (1.6 lb)

All data subject to change without notice.



AGM Global Vision, LLC

MAIN OFFICE

173 West Main Street

PO Box 962

Springerville, AZ 85938

USA

Tel. +1.928.333.4300

info@agmglobalvision.com

www.agmglobalvision.com

EUROPEAN OFFICE

#6 Andrey Lyapchev Blvd

Sofia, P.C. 1756

Bulgaria

Tel. +35.988.560.0326

info@agmglobalvision.eu

www.agmglobalvision.eu

DOWNLOAD AGM CONNECT APP:



Google Play Store



Apple App Store

AGMglobalvision.com